



County Hall
Cardiff
CF10 4UW
Tel: (029) 2087 2000

Neuadd y Sir
Caerdydd
CF10 4UW
Ffôn: (029) 2087 2000

AGENDA

Committee	ECONOMY & CULTURE SCRUTINY COMMITTEE
Date and Time of Meeting	TUESDAY, 24 OCTOBER 2023, 5.15 PM
Venue	CR 4, COUNTY HALL - MULTI LOCATION MEETING
Membership	Councillor Wong (Chair) Councillors Berman, Brown-Reckless, Henshaw, Jenkins, Jones, Lloyd Jones, Shimmin, Thomson

Time
approx.

1 Apologies for Absence

To receive apologies for absence.

2 Declarations of Interest

To be made at the start of the agenda item in question, in accordance with the Members' Code of Conduct.

3 Minutes (Pages 5 - 10)

To approve as a correct record the minutes of the previous meeting.

4 St David's Hall Update (Pages 11 - 278)

Pre Decision Scrutiny of a report to Cabinet.

Appendix 3 of this report is not for publication as it contains exempt information of the description contained in paragraphs 14 and 16 of Part 4 of Schedule 12A of the Local Government Act 1972. In all the circumstances of the case, the public interest in maintaining the exemption outweighs the public interest in disclosing the information.

5 Urgent Items (if any)

6 Way Forward

7 Date of next meeting

21/11/2023, 4.30pm

Davina Fiore

Director Governance & Legal Services

Date: Wednesday, 18 October 2023

Contact: Andrea Redmond, 02920 872434, a.redmond@cardiff.gov.uk

WEBCASTING

This meeting will be filmed for live and/or subsequent broadcast on the Council's website. The whole of the meeting will be filmed, except where there are confidential or exempt items, and the footage will be on the website for 6 months. A copy of it will also be retained in accordance with the Council's data retention policy.

Members of the press and public may also film or record this meeting.

If you make a representation to the meeting you will be deemed to have consented to being filmed. By entering the body of the Chamber or meeting room you are also consenting to being filmed and to the possible use of those images and sound recordings for webcasting, public information, press coverage and/or training purposes.

If you have any queries regarding webcasting of meetings, please contact Democratic Services on 02920 872020 or email [Democratic Services](#)

This page is intentionally left blank

ECONOMY & CULTURE SCRUTINY COMMITTEE

19 SEPTEMBER 2023

Present: Councillor Wong(Chairperson)
Councillors Berman, Henshaw, Jenkins, Jones, Lloyd Jones,
Shimmin and Thomson

28 : APOLOGIES FOR ABSENCE

Apologies were received from Cllr. Brown-Reckless.

Angela Holt (Principal Scrutiny Officer) was also absent, with Nicola Newton and Erica Painter taking her place.

29 : DECLARATIONS OF INTEREST

There were none.

30 : MINUTES

The minutes of the meetings held on 11th July 2023 and 3rd August 2023 were agreed as a correct record and signed by the Chair.

31 : SHARED PROSPERITY FUND

Members were advised that this item sought to provide background information to aid the scrutiny of the draft report to Cabinet titled 'Shared Prosperity Fund Update', which was due to be considered by Cabinet at their meeting on 21st September 2023. The revised delivery program covered a total of £8.3m of funding, and the report examined proposed programs, delivery steps, the role of the council and the proposed management arrangements.

The Chairperson welcomed:

- Cllr. Huw Thomas, Leader of the Council
- Jon Day, Cardiff Council's OM Tourism and Investment
- Natalie Southgate, Cardiff Council's Partnership Delivery Manager, Housing & Communities
- Louise Bassett, Cardiff Council's OM Partnerships & Commissioning, Housing and Communities
- James Wilcox, Cardiff Council's Project Commissioning Officer, Housing & Communities

The Leader of the Council was invited to make an opening statement, in which he emphasised that the proposals were informed by engagement and conversations with key partners, and highlighted the importance of spending within communities. While the initial spend profile had focused on council services to benefit communities and businesses, this report outlined their intention to work more now with external organisations in delivering the remainder of the funding.

Officers provided a presentation, which explained that the council had spent £5.2m last year within communities via the Shared Prosperity Fund, and with 18 months left of the program there was a need to up the pace of spending. Of all the applications they had received, the new approved schemes would go live in October. The funds allocated had focused on the council's priorities, including community facilities, neighbourhood regeneration, public safety, Child Friendly Cardiff, Into Work services, financial advice and adult literacy.

Members asked how Open Call funding would ensure community needs were taken into account rather than better organised applicants getting priority. Officers assured the Committee that their analysis was comprehensive and outcome led. Members discussed the branding of schemes linked to Levelling Up funding and heard that there were no clear details on this yet, unlike EU structural funding received in the past.

Members highlighted the longevity of projects as a key factor and noted that gaps could appear in funding, especially in third sector projects, which in turn might prevent good projects being submitted. Officers acknowledged that third sector grants would be affected when the current funding round ended at the next general election, although the Leader of the Council noted that it was hard to envision the SPF coming to an end without a successor scheme being created.

Members discussed the bureaucratic side of the fund and heard that schemes could claim up to 4% to manage administrative costs. The Leader agreed with Members that there was a strong case for block grants.

The Committee approved of the recommendations in the report as a whole. Members highlighted pockets of need in north Cardiff, and officers confirmed that there was the opportunity to bid in years 2 and 3. The Youth Council representative praised the focus on local projects and emphasised that realistic expectations were key.

AGREED: that the Chairperson, on behalf of the Committee, writes to the Cabinet Member conveying the observations of the Committee when discussing the way forward.

32 : CARDIFF MARKET RESTORATION PROJECT

Members were advised that this item sought to provide background information to aid the scrutiny of the draft report to Cabinet titled 'Cardiff Market Restoration Project', which was due to be considered by Cabinet at their meeting on 21st September 2023.

The Chairperson welcomed:

- Cllr. Huw Thomas, Leader of the Council
- Jon Day, Cardiff Council's OM Tourism and Investment
- Eirian Jones, Cardiff Council's OM Strategic Estates Manager
- Louise Thomas, Cardiff Council's Asset Management Officer, Strategic Estates

The Leader of the Council was invited to make an opening statement, in which he described the market as a fantastic asset to the city and a critical anchor of the council's post-Covid recovery strategy. He noted that while it remained thriving and vibrant, the building was in need of investment, and there were other covered markets around the country that were even more of a destination than Cardiff's.

This was followed by a presentation from Jon Day which set out how the council intended to invest £6m in its refurbishment, focusing on renovation and restoration rather than redevelopment. He highlighted issues with the roof, drainage and lighting, as well as a lack of meeting space and anything that recognised or showcased the building's heritage. Officers had explored a number of different options including a complete or phased closure, and concluded that with so many traditional and established tenants it was important to keep the market open as much as possible. The work would be phased, requiring some temporary relocation of tenants but for no more than a 12 week period.

Members were then asked for their questions, comments and observations. They were pleased to hear that the restoration would keep stallholders in mind, and highlighted the need for displaced tenants to have equity in the spaces they were relocated to. Consultation was key, and the Committee heard that 80% of stallholders had attended an open day put on by the council to cover these issues, while those who didn't attend had been contacted separately. Officers also reassured Members that they were in regular dialogue with stallholders in order to respond to their concerns proactively.

The Committee heard that footfall was consistently increasing on both the ground floor and balcony, with around 2.5 million visitors in total expected this year. Officers were considering various ways to make the market more accessible to groups who might not normally come to it, including the Learning Suite, new seating area and additional outreach work with schools both inside and outside Cardiff. Members heard that the seats in the seating area would be more accessible and advocated providing Changing Places toilets for both children and adults, which officers agreed to consider.

Members heard that five tenants would be displaced by the new ground floor seating area and would be offered similar alternative spaces, on the ground floor and on the same aisle where possible. The Committee discussed the rents charged, noting that the last review took place in 2017, and heard that the next one would take place when the restoration was complete.

Members explored the relationship between food and retail, emphasising the need to preserve the latter, and were reassured by officers that their goal was to maintain the current mix of about 45% food to 55% retail. Members suggested that a food-only model like Newport Market would not suit Cardiff, and advocated modelling the long-term sustainability of different market models in case there was a shift over time.

AGREED: that the Chairperson, on behalf of the Committee, writes to the Cabinet Member conveying the observations of the Committee when discussing the way forward.

33 : CABINET RESPONSE - SHAPING CARDIFF'S POST PANDEMIC ECONOMIC RECOVERY

Members were advised that this item sought to update them on the Cabinet response to the recommendations made in the Economy & Culture Scrutiny Committee January 2023 inquiry report 'Shaping Cardiff's Post Pandemic Economic Recovery.' 16 of the recommendations had been fully accepted, while the other three (12, 17 and 19) had been partially accepted.

The Chairperson welcomed:

- Cllr. Huw Thomas, Leader of the Council
- Jon Day, Cardiff Council's OM Tourism and Investment
- Rebecca Hooper, Cardiff Council's OM Neighbourhood Regeneration, Housing Development & Regeneration
- Ken Poole, Cardiff Council's Head of Economic Development

The Leader of the Council was invited to make an opening statement, in which he noted that much of the work to fulfil the recommendations had already begun. Those which were partially accepted were on grounds of deliverability and viability, and the spirit of the report was fully endorsed by the Cabinet.

Members were asked for their questions, comments and observations, and highlighted the recommendation on enhanced city centre management arrangements which was under review and queried what this review would look like, for instance in terms of timescale. Officers confirmed that they were taking on board comments from ward members and businesses and would respond in due course.

AGREED: that the Chairperson, on behalf of the Committee, writes to the Cabinet Member conveying the observations of the Committee when discussing the way forward.

34 : CARDIFF CAPITAL REGION CITY DEAL JOINT OVERVIEW & SCRUTINY COMMITTEE: UPDATE; AND PROPOSALS IN RELATION TO SCRUTINY OF THE SOUTH EAST WALES CORPORATE JOINT COMMITTEE

Members were advised that this report provided Members with an update on meetings of the Cardiff Capital Region City Deal (CCRCD) Cabinet and the CCRCD Joint Overview & Scrutiny Committee (JOSC), following the last update provided at Committee in January 2023, and sought agreement of proposals in relation to scrutiny of the South East Wales Corporate Joint Committee (CJC).

The Chairperson welcomed:

- Cllr. Owen Jones, Chair of the Environmental Scrutiny Committee

The Scrutiny Officer explained that both Cllr. Wong and Cllr. Jones sat on the joint committee on behalf of the council, and that all ten constituent local authorities had been asked to review and approve the draft terms of reference. Members were asked for their questions, comments and observations.

The Committee agreed with the recommendation from Rhondda Cynon Taf County Borough Council that the terms of reference should be reviewed at the first meeting, and emphasised that robust terms of reference would be required in order to maintain high standards of transparency and accountability. The joint committee oversaw tens of millions of pounds worth of projects across ten authorities, and also had Cardiff's name in the title, so there was significant reputational risk as well as financial.

Members raised concerns around the democratic pathway, especially the questions of how the joint committee selected its topics of scrutiny and how it reported back to the constituent authorities. There was frustration around the level of transparency and engagement that the committee provided compared to Cardiff Council's own scrutiny committees, with Members noting the issue of access to confidential papers. The Committee advocated greater accessibility and visibility in terms of where exactly the JOSC's output went, and suggested circulating papers, agendas and minutes to all members of the constituent authorities to improve engagement.

The Committee noted that it would be difficult to carry out proper scrutiny of such a large portfolio when the joint committee only met four times a year, and queried their terms of office. Members suggested that quotas could be implemented to improve diversity, and noted that it would be useful to see the relevant Equality Impact Assessments. Members queried whether non-attendance was reported back to the constituent local authorities, and whether there were any sanctions associated with this.

AGREED: that the Chairperson, on behalf of the Committee, writes to the Cabinet Member conveying the observations of the Committee when discussing the way forward.

35 : CORRESPONDENCE

The Committee noted that there were no responses outstanding from the letters sent out since the last update.

36 : URGENT ITEMS (IF ANY)

There were none.

37 : DATE OF NEXT MEETING

17th October 2023 at 4:30pm.

The meeting terminated at 7.10 pm

This page is intentionally left blank

CYNGOR CAERDYDD
CARDIFF COUNCIL

ECONOMY & CULTURE SCRUTINY COMMITTEE

24 OCTOBER 2023

ST DAVID'S HALL - UPDATE

Appendix 3 of Appendix A is not for publication as it contains exempt information of the description contained in paragraphs 14 and 16 of Part 4 of Schedule 12A of the Local Government Act 1972. It is viewed that, in all the circumstances of the case, the public interest in maintaining the exemption outweighs the public interest in disclosing the information.

Purpose of the Report

1. To provide background information to Members to aid their scrutiny of the report to Cabinet, titled '*St David's Hall Update*', which is due to be considered by Cabinet at their meeting on 26 October 2023.

Structure of papers

2. Attached to this cover report are the following appendices:
 - i. Appendix A – report to Cabinet titled '*St David's Hall.*'
 - a. Appendix 1 – Visual Images of RAAC Planks
 - b. Appendix 2 – Engineers Report
 - c. Confidential Appendix 3 – Legal Advice and Documents
 - d. Appendix 4 – Single Impact Assessment
3. Members should note that **Appendix 3 of Appendix A** is exempt from publication. Members are requested to keep this information confidential, in line with their responsibilities as set out in the Members' Code of Conduct.

Scope of Scrutiny

4. At their meeting on 26 October 2023, Cabinet will consider a report that presents the outcome of intrusive surveys of the roof of St. David's Hall and seeks delegated authority to:
 - i. finalise and enter into a Conditional Agreement for Lease with AMG
 - ii. enter into the lease and associated documents upon satisfaction of the conditions within the Conditional Agreement for Lease, and

- iii. complete the business sales agreement with AMG.
5. Cabinet is also recommended to:
- i. Note the continued closure of St. David's Hall and associated consequences,
 - ii. Note the Council's proposed staff engagement strategy.
6. During this scrutiny, Members have the opportunity to explore:
- i. The findings of the survey of St. David's Hall roof
 - ii. The impact of the survey findings, including continued closure
 - iii. The proposed Conditional Agreement for Lease
 - iv. The proposed lease, business sale agreement and associated documents
 - v. The proposed staff engagement strategy
 - vi. The financial, legal, property and HR implications
 - vii. Whether there are any risks to the Council
 - viii. The timeline and next steps.

Structure of the meeting

7. The Chair will move that this item be considered in two parts: an open session, where Members will be able to ask questions on the papers that are in the public domain, namely this cover report and the report to Cabinet attached at **Appendix A, and its appendices 1, 2 and 4**; and a closed session, where members of the public will be excluded, where Members can ask questions that pertain to **Confidential Appendix 3 of Appendix A**.
8. Members will hear from Councillor Burke (Cabinet Member – Culture, Parks and Events). Neil Hanratty (Director of Economic Development), Chris Barnett (OM Major Projects), Ruth Cayford (Operational Manager –Creative Industries and Culture), Donna Jones (Assistant Director – County Estates), Eirian Jones (OM Strategic Estates), Tracey Thomas (Chief Officer – HR), Scott Couzens (Bevan Britten – the Council's legal advisors on this matter) and Chris Pembridge (WSP – the Council's structural engineers on this matter) will also attend the meeting. Members will be able to ask questions of the panel.

9. Members will then be able to decide what comments, observations or recommendations they wish to pass on to the Cabinet for their consideration prior to Cabinet on 26 October 2023.

Background

10. At their meetings in December 2022 and July 2023, Cabinet considered reports regarding St. David's Hall, agreeing to:
- i. delegate authority to conclude negotiations with AMG to complete the lease and business sale agreement for St David's Hall and
 - ii. authorise the transfer of employees to AMG under the Transfer of Undertaking (Protection of Employment Regulations 2006) (TUPE).
11. St. David's Hall's roof comprises Reinforced Autoclaved Aerated Concrete (RAAC) planks across the main roof span, covered with a bitumen lining, and woodwool concrete in the vertical mansard, which is clad in lead; images are provided at **Appendix 1**.
12. In August 2023, the Health and Safety Executive issued revised guidance regarding the use of RAAC planks, advising that the use of RAAC planks was at the end of their useful life and they could collapse without warning.
13. In September 2023, the Council temporarily closed St. David's Hall to enable intrusive surveys to identify whether the building risk was RED 'critical' or RED 'high-risk'. The Engineers Report, at **Appendix 2**, outlines the level of risk as RED Critical and that the RAAC planks need to be replaced or a remedial solution needs to be implemented prior to re-opening the building.

Issues identified in the Cabinet Report

14. The report to Cabinet contains the following sections:
- i. **Points 10-17** – set out the key issues relating to the roof
 - ii. **Points 18- 24** – set out the proposed agreement with AMG
 - iii. **Points 25- 31** – set out the proposed staff engagement strategy.

15. The main points contained in the report are:

Roof

- i. The entire roof cladding needs to be replaced within the next 1-3 years
- ii. It is better to have a comprehensive full replacement, rather than a temporary fix followed by a full replacement, for three reasons: affordability, minimising the overall closure period, and insurance risk and liability.

AMG

- iii. AMG has confirmed they are committed to investing in St. David's Hall and wish to proceed with the transaction
- iv. A conditional lease will provide AMG assurance to spend monies required to undertake detailed design works and submit applications for planning permission and listed building consent
- v. The lease would complete 30 days after planning permission and listed building consent are achieved, provided AMG are still willing to go ahead with the lease; AMG anticipate the lease becoming unconditional in less than 12 months
- vi. A 12-month period, subject to extensions to a maximum of a further 24 months, is proposed for condition satisfaction; if conditions are not satisfied within this timeframe, either party may terminate the agreement. This means there is no guarantee at this time that the venue will transfer to AMG and re-open as proposed
- vii. AMG has suggested establishing a working group with representatives from AMG and the Council to manage requirements and ensure a positive and swift outcome that meets conservation, planning and listed building requirements, acoustic requirements and safety requirements
- viii. AMG has committed to undertake wider refurbishment works whilst the building is closed, meaning further closures are not anticipated.

Staff Engagement

- ix. It is likely St. David's Hall will be closed for circa 18 months
- x. The Council cannot justify retaining staff in ungainful employment for this length of time and needs to formally consult with staff and their representatives regarding future options

- xi. The Council will offer all permanent and casual staff with acquired rights, including agency staff with over 2 years' service, the opportunity for voluntary severance and redeployment
- xii. Agency staff with under 2 years' service will be released from their assignments
- xiii. AMG has offered to make existing staff aware of vacancies within their wider business.
- xiv. Voluntary Severance costs to the Council will be worked through as part of the staff consultation process.

16. In terms of the next steps, the report sets out the Council needs to:

- i. Consult staff and their representatives regarding potential redeployment/ voluntary redundancy/ redundancy measures
- ii. Enter into a Conditional Agreement for Lease with AMG and establish a working group
- iii. Confirm longer-term closure, including working with AMG to book new events and re-programme current bookings
- iv. Conclude the work to determine tax implications and appropriate structure for the transaction.
- v. Enter into the Lease and Business Sale Agreement, once conditions are satisfied and if the proposed transaction remains viable.

17. **Financial Implications** are at **points 39- 49**, and highlight:

- i. The replacement of the roof and other issues relating to the fabric of the building far exceeds the available capital budgets within the Council's programme
- ii. The proposed lease requires no Council capital investment, future buildings liability and no committed annual revenue payments or subsidy
- iii. The offer provides for the continuation of the classical programme requiring no ongoing contribution from the Council
- iv. Minimal annual costs to the Council re St. David's Hall consist of permanent employees staffing costs of circa £1.5m per annum and premises costs of circa £600,000 per annum; the Council will be liable for these costs until the unconditional lease becomes active.

- v. The Council will explore whether it is able to reduce premises costs, by reducing utility costs and rates
- vi. The Council will consult staff and their representatives on potential redeployment / voluntary redundancy / redundancy measures to best mitigate the costs identified above, considered on a case-by-case basis
- vii. There is a risk that the Council may be open to potential claims for compensation from promoters for performances being rescheduled or postponed
- viii. The Council needs to be satisfied that best value applies, considering the latest information on the roof risks, TUPE, employee and Pension Fund implications, as well as business sale agreement obligations
- ix. Further consideration will need to be given to the legal, procurement, VAT, and tax implications of the proposals as the transfer documentation is finalised in order to ensure that the structure of any final contract sufficiently protects the Council's interests.

18. Legal Implications are at **points 50 - 63** and highlight:

- i. Legal advice in relation to proposed transaction is at **Confidential Appendix 3**
- ii. The legal basis for disposal of Council-owned land, including best consideration duty and advice received on this
- iii. The Council previously obtained KC advice regarding subsidy control
- iv. Cabinet will need to remain satisfied, with reference to the advice received from the independent surveyor, from King's Counsel (and subject to satisfactory resolution of the points to be addressed in King's Counsel's advice), and in light of the closure of the venue and need for urgent repairs and replacement of the roof to allow the venue to operate (and the increased upfront cost that AMG will need to bear in relation to such repairs), that the disposal by way of a 45 year lease to AMG continues to meet the best consideration duty.
- v. Cabinet needs to take account of the Council's fiduciary duties to local residents and taxpayers
- vi. The need for the decision maker to consider its duties with regard to the Equality Act 2010, the Public Sector Equality Duties, the Well-Being of

Future Generations (Wales) Act 2015, and the Welsh Language (Wales) Measure 2011 and Welsh Language Standards

- vii. Employment Law – the closure of St. David’s Hall, as opposed to a transfer of the staff under TUPE, means that the Council may need to make the staff working at the Hall redundant unless it is possible to redeploy them elsewhere within the Council or otherwise avoid redundancies. Prior to any such decisions being made, the Council should consult with the appropriate representatives of the affected staff under s188 Trade Union Labour Relations (Consolidation) Act 1992 and follow a fair process in relation to any redundancy proposals, including consulting with affected staff individually, to try to mitigate the need for any redundancies.

19. Property Implications are at **points 64-70** including:

- i. Without prejudice to its capacity as planning authority, the Council is obligated to provide reasonable co-operation to AMG to satisfy the conditions to the agreement for lease, in its capacity as landowner
- ii. From exchange of the agreement, the parties will be bound to enter into the lease and business sale agreement following satisfaction of the conditions
- iii. Without an agreement for lease, either party could withdraw from the transaction with no notice or reason. In addition, AMG may be unlikely to proceed without assurance that the additional works required are viable.

20. Points 71-80 set out the **HR implications** for the Council arising from this report, including:

- i. In July 2023, Cabinet authorised the transfer of employees to AMG under the Transfer of Undertaking (Protection of Employment) Regulations 2006, as amended (TUPE)
- ii. Since closure of St. David’s Hall, some employees are undertaking their roles through hybrid working, some are working at alternative venues such as County Hall, and casual workers have been offered alternative work opportunities at various venues
- iii. The need to replace the roof means the Council is not able to inform employees when the building is likely to re-open and become operational as a venue – this has significant implications for employees

- iv. It is unlikely TUPE would apply given the number of uncertainties and variables and length of the potential closure, but this would be fact dependent on the circumstances and could only be tested through legal routes
- v. Given the impact of the uncertainty of the future opening and operation of St. David's Hall on employees and the ongoing salary liabilities to the Council whilst the venue is closed, the Council should undertake a period of consultation with employees and trade unions in respect of potential redundancy risks
- vi. The Council will make every effort to mitigate the need for any redundancies and will in the first instance seek expressions of interest from employees in Voluntary Severance and will also seek to redeploy employees to alternative roles within the Council via the Corporate Redeployment Scheme
- vii. Employees who are seeking redeployment will remain on the redeployment register for a period of 12 weeks whilst suitable alternative employment opportunities are sought. At the end of the 12-week period, should the Council not be able to secure alternative employment, employees will be made redundant and would receive redundancy payments based on the Council's enhanced redundancy payments scheme
- viii. All expressions of interest in Voluntary Severance would need to be considered on a case-by-case basis considering any pension fund implications
- ix. It is essential that employees are fully briefed, consulted and supported throughout the formal consultation process
- x. The trade unions, employees and agency workers have been briefed on the recommendations set out in this report. Should Cabinet agree to the recommendations, a formal consultation period will commence under s188 Trade Union Labour Relations (Consolidation) Act 1992.

Proposed Recommendations to Cabinet

21. The report to Cabinet contains the following recommendations:

1. *Delegate authority to the Director of Economic Development in consultation with the Cabinet Member for Culture, Parks and Events, the Section 151 Officer, and the Legal Officer to conclude negotiations with AMG and other relevant stakeholders to:*

- a. *Finalise and enter into a Conditional Agreement for Lease with AMG on the basis of the principles set out in the draft Conditional Agreement for Lease set out at **Confidential Appendix 3**;*
 - b. *Enter into the lease and associated documents as set out at **Confidential Appendix 3** upon satisfaction of the conditions within the Conditional Agreement for Lease;*
 - c. *Complete the business sales agreement with AMG for St David's Hall based on the principles set out in the draft business sales agreement attached at **Confidential Appendix 3** upon satisfaction of the conditions within the Conditional Agreement for Lease;*
2. *Note the continued closure of St David's Hall and the associated consequences set out in this report until AMG satisfy the conditions within the Conditional Agreement to Lease.*
 3. *In light of the above, it is unlikely that all employees will transfer to AMG under the Transfer of Undertaking (Protection of Employment Regulations 2006) as envisaged in the July 2023 Cabinet report. As a result, to note the Council's proposed staff engagement strategy to manage the closure of St David's Hall as set out in this report.*

Previous Scrutiny

22. In December 2022, this Committee undertook pre-decision scrutiny of the report to Cabinet titled 'St David's Hall'. Members heard from Cllr Burke (Cabinet Member – Culture, Parks and Events), council officers, and Ceri Williams from Cardiff Civic Society. Members also received copies of representations made to the Committee by 22 members of the public, via the Scrutiny Viewpoints mailbox.

23. At the meeting, Members explored the proposals, focusing specifically on funding, process proposed, negotiations to date, consultation, and confidential information. Following this scrutiny, the Chair wrote a public and a confidential letter¹ to Cllr Burke, conveying the Committee's comments, observations and recommendations. Members made two requests for information and four recommendations. Cllr Burke responded to this letter², accepting all the recommendations; the Sandy Brown report was released into the public domain the day after the scrutiny committee meeting.

¹ The confidential letter has previously been circulated to Members and the public letter is available [here](#)

² Available [here](#)

24. In May 2023, this Committee scrutinised key documents relating to the proposed property transfer of St David's Hall, including the Voluntary Ex-Ante Transparency Notice (VEAT notice). Members scrutinised the soft marketing exercise, KC advice regarding the proposed transaction qualifying as a property transaction, the VEAT notice, the classical programme and community events, key stakeholder advisory group, liabilities and obligations, ticket prices, the lack of a commercial connection between this work and the work on the Indoor Arena, and the lack of contact from the Competition and Markets Authority.

25. Following this scrutiny, the Chair wrote a public and a confidential letter³ to Cllr Burke, conveying the Committee's comments, observations and recommendations. In the public letter, Members made one request for information. Cllr Burke responded to this letter⁴, providing details of the protected programme based on a typical year's classical/ community programme. In the confidential letter sent following scrutiny in May 2023, Members made one recommendation; this was partially accepted as detailed in the response received from Councillor Burke, Cabinet Member – Culture, Parks and Events, which has been circulated to Committee Members. Members also made a request for additional information, which was provided.

26. In July 2023, this Committee scrutinised key documents relating to the proposed business sale agreement, the full repairing and insuring lease, the draft Memorandum of Understanding, and the Repairs Schedule, including KC advice on the proposed transaction.

27. Following scrutiny in July 2023, the Chair wrote a public and a confidential letter⁵ to Cllr Burke, conveying the Committee's comments, observations and recommendations. In the confidential letter, Members made one recommendation; this was accepted as detailed in the response received from Councillor Burke,

³ The confidential letter has previously been circulated to Members and the public letter is available [here](#)

⁴ Available [here](#)

⁵ The confidential letter has previously been circulated to Members and the public letter is available [here](#)

Cabinet Member – Culture, Parks and Events, which has been circulated to Committee Members.

Way Forward

28. Councillor Burke (Cabinet Member – Culture, Parks and Events) will be invited to make a statement. Neil Hanratty (Director of Economic Development), Chris Barnett (Operational Manager – Major Projects), Ruth Cayford (Operational Manager – Creative Industries and Culture), Donna Jones (Assistant Director – County Estates) and Eirian Jones (Operational Manager – Strategic Estates) will attend, along with Tracey Thomas (Chief Officer - HR) and Scott Couzens (Bevan Britten – the Council’s legal advisors on this matter). All witnesses will be available to answer Members’ questions.

29. All Members are reminded of the need to maintain confidentiality regarding the information provided in **Appendix 3 of Appendix A**. Members will be invited to agree the meeting go into closed session to enable discussion of this information.

Legal Implications

30. The Scrutiny Committee is empowered to enquire, consider, review, and recommend but not to make policy decisions. As the recommendations in this report are to consider and review matters, there are no direct legal implications. However, legal implications may arise if and when the matters under review are implemented with or without any modifications. Any report with recommendations for decision that goes to Cabinet/Council will set out any legal implications arising from those recommendations. All decisions taken by or on behalf of the Council must (a) be within the legal powers of the Council; (b) comply with any procedural requirement imposed by law; (c) be within the powers of the body or person exercising powers on behalf of the Council; (d) be undertaken in accordance with the procedural requirements imposed by the Council e.g. Scrutiny Procedure Rules; (e) be fully and properly informed; (f) be properly motivated; (g) be taken having regard to the Council's fiduciary duty to its taxpayers; and (h) be reasonable and proper in all the circumstances.

Financial Implications

31. The Scrutiny Committee is empowered to enquire, consider, review, and recommend but not to make policy decisions. As the recommendations in this report are to consider and review matters, there are no direct financial implications at this stage in relation to any of the work programme. However, financial implications may arise if and when the matters under review are implemented with or without any modifications. Any report with recommendations for decision that goes to Cabinet/Council will set out any financial implications arising from those recommendations.

RECOMMENDATION

The Committee is recommended to:

- i) Consider the information in this report, its appendices, and the information presented at the meeting
- ii) Determine whether they would like to make any comments, observations or recommendations to the Cabinet on this matter, and
- iii) Decide the way forward for any future scrutiny of the issues discussed.

DAVINA FIORE

Director of Governance & Legal Services

18 October 2023

CABINET MEETING: October 2023

ST DAVID'S HALL UPDATE

CULTURE, PARKS & EVENTS (COUNCILLOR JEN BURKE)

AGENDA ITEM:

PORTFOLIO: INVESTMENT & DEVELOPMENT

Appendix 3 of this report are not for publication as they contain exempt information of the description contained in paragraphs 14 and 16 of Part 4 of Schedule 12A of the Local Government Act 1972. In all the circumstances of the case, the public interest in maintaining the exemption outweighs the public interest in disclosing the information.

Reason for this Report

1. To provide an update on the proposed lease of St David's Hall to AMG following the recent enforced closure of the building due to the roof structure containing RAAC (Reinforced Autoclaved Aerated Concrete) planks.
2. To seek approval to finalise and enter into a Conditional Agreement for Lease with AMG which, subject to the conditions being satisfied and viable, will allow the Council to transfer the business of St David's Hall via a business sale agreement and enter a full repairing and insuring 45-year lease with AMG (as previously agreed by Cabinet in July 2023) to protect the venue and to develop and maintain the music and cultural/community offer including the classical programme.
3. To present the outcome of the intrusive surveys of the roof of St David's Hall and the subsequent impact on the decisions taken for the future of St David's Hall.
4. To outline the proposed staff engagement strategy to manage the closure of St David's Hall until such time AMG has satisfied the conditions within the Conditional Agreement to Lease and concluded the required works.

Background

5. In July 2023, Cabinet delegated authority to conclude negotiations with AMG to complete the lease and business sales agreement for St David's Hall and authorised the transfer of employees to AMG under the Transfer of Undertaking (Protection of Employment Regulations 2006) (TUPE).
6. In August 2023, revised guidance from the Health and Safety Executive was issued following the collapse of a school roof in Kent which contained RAAC planks in the roof structure (previously regarded as "low risk"). The HSE advised that the use of RAAC planks was at the end of their useful life and that they could collapse without warning.
7. The St David's Hall roof comprises two main materials: Reinforced Autoclaved Aerated Concrete (RAAC) planks across the main roof span covered with a bitumen lining, and woodwool concrete in the vertical mansard which is clad in lead. (See images at **Appendix 1**).
8. In September 2023, following advice from the Council's appointed specialist engineers, the Council took the decision to temporarily close St David's Hall to allow intrusive surveys of the RAAC planks and structural steel to be undertaken. This was to better understand and determine the condition of the planks and whether they posed safety concerns.
9. Since closure in September 2023 and based on ongoing monitoring undertaken in relation to the RAAC planks the Council's appointed engineers have categorised the building as a RED risk (the highest category of risk rating available). Considering this, the intrusive surveys commissioned were to identify whether the building risk was RED "critical" or RED "high-risk". The engineers report attached at **Appendix 2** outlines the level of risk RED Critical Risk and that the RAAC planks need to be replaced or a remedial solution needs to be implemented prior to re-opening of the building.

Issues

10. Given the 30-year life span of RAAC and the additional presence of the woodwool concrete in the vertical mansard the Council has been advised that the entire roof cladding will need to be replaced within the next 1-3 years.
11. The replacement of the St David's Hall roof will be a complicated and costly exercise for the following reasons:
 - the city centre location in the Hayes,
 - the height of the roof/ceiling,
 - the Building has recently been listed as having special architectural and historical interest.
 - the requirement to preserve the acoustic quality of the venue,
 - the likely requirements for planning permission

All the above will inevitably create a complex and time-consuming process to find a viable solution. AMG has also estimated that the cost of full replacement is likely to be 4-5 times more expensive than their original plan to provide a remedial solution in the early part of the lease.

12. The Council's priority is to get St David's Hall safely re-opened as quickly as possible. A full replacement of the roof will now be required much earlier in the programme of maintenance and refurbishment than was previously expected. Any short-term remedial solution would need to be very quickly followed by a more comprehensive full replacement. Therefore, whilst a temporary fix may get the building re-opened more quickly, it is likely that the venue would need to close again within the next 1-3 years for a full replacement. The substantial cost of the full replacement makes a short-term temporary fix unrealistic on affordability grounds. Furthermore, whilst a temporary fix would get the building initially re-opened more quickly, the cumulative length of closure for the short-term solution followed by a full replacement would mean a longer period of closure during the next 1-3 years than undertaking a full replacement from the outset.
13. Further to the above, any short-term remedial solution would also need to be approved by insurers as the risk of failure would remain until the roof is replaced, as the RAAC planks are at the end of their useful life.. AMG has confirmed to the Council that they would not wish to reopen the venue until all of the RAAC planks have been removed and a full replacement roof has been delivered, and therefore if the venue was to open with a short-term remedial solution, the potential risk of failure would ultimately need to remain with the Council.
14. As the building is going to need to be closed for a substantial period of time to undertake works there is a need to agree a way forward for the existing Council staff employed at the venue.
15. The length of time a short-term remedial solution will delay the need for a full roof replacement is also unknown at this time and will only be determined once an engineered scheme has been designed and approved.
16. AMG has confirmed to the Council that they would not wish to reopen the venue until a full replacement roof has been delivered, and therefore if the venue was to open with a short-term remedial solution, the risk of failure would ultimately need to be accepted by the Council and its insurers.
17. As the building is going to need to be closed for a substantial period of time to undertake works there is a need to agree a way forward for the existing Council staff employed at the venue.

Proposed Agreement with AMG

18. Despite the solidification of the RAAC plank risk, AMG has confirmed that they remain committed to investing in St David's Hall and would still wish to proceed with the proposed transaction previously agreed by Cabinet in the July 2023.

19. However, in light of the recent developments, they would initially require the business sale agreement and associated lease to be conditional to enable them to work towards identifying a viable solution and to secure planning permission and listed building consent for the required works to the roof and other parts of the building.
20. Entering into a Conditional Agreement for Lease as an initial step will provide AMG with the assurance to spend the required sums to undertake the detailed design works and to submit applications for listed building consent and planning if required. Once these are achieved, provided AMG are still willing to go ahead the lease would complete 30 days later, in advance of AMG undertaking works. The costs of undertaking the design works will be at AMG's risk.
21. If the conditions are not satisfied by 12 months from entering the conditional lease, subject to extensions of up to a maximum of a further 24 months pending final determination of a submitted or appealed planning application, either party may terminate the agreement. On this basis, there is no guarantee at this time that the venue will transfer to AMG and re-open as proposed.
22. It is therefore proposed that the Council enter into a Conditional Agreement for Lease capturing the conditions set out above. The draft Conditional Agreement for Lease is appended at **Confidential Appendix 3**.
23. Even though the timelines outline a period of potentially up to 36-months to satisfy the abovementioned conditions AMG is committed to delivering the solution as quickly as possible and anticipate the lease becoming unconditional in less than 12 months. The key consideration will be how they deliver a viable solution that meets conservation, planning and listed building requirements, acoustic and safety requirements. AMG has suggested a working group will be required made-up of representatives from both AMG and the Council to manage the requirements to ensure a positive and swift outcome. AMG's aspiration is to re-open the building in circa 18 months from entering the Conditional Agreement to Lease and they are targeting a re-opening well in advance of the next BBC Cardiff Singer of the World competition in July 2025.
24. AMG has also committed to undertake the wider refurbishment works that they proposed within their original maintenance and refurbishment programme, upfront, whilst the building is closed to deal with the roof, and therefore the building will re-open without the requirement for any further anticipated closures.

Staff Engagement

25. The extended closure of St David's Hall will have major implications for the staff currently employed at the venue. Given that the building is likely to be closed for circa 18 months, the Council will not be able to justify retaining staff

in ungainful employment for that period of time. The estimated cost of retaining staff is set out in the financial implications of this report.

26. The Council will therefore need to formally consult with staff and their representatives regarding future options with immediate effect.
27. All permanent staff, and temporary and casual staff with acquired rights, will be offered the opportunity for voluntary severance.
28. The staff identified above will also be offered the opportunity to access the redeployment register to be considered for redeployment into suitable alternative roles within the Council subject to the Council's redeployment process. Staff that prefer to be redeployed but are unsuccessful in securing a new position through the redeployment process will still have the benefit of redundancy on the same terms as voluntary severance at the end of the redeployment process.
29. Agency staff with over 2 years of service will be included in the process based on their service. Agency staff with under 2 years of service will be released from their assignments.
30. AMG has also offered to engage with all existing staff to make them aware of vacancies that can be applied for within their wider business.
31. The costs to the Council associated with voluntary severance will be worked through as part of the staff consultation process.

Next Steps

32. The Council is required to consult with all employees currently employed at St David's Hall and their representatives in relation to potential redeployment/voluntary redundancy/redundancy measures.
33. It is proposed that the Council enters into a Conditional Agreement for Lease with AMG for St David's Hall by the end of October 2023.
34. The Council will need to confirm a longer-term closure of the venue whilst the viable solution for the roof is designed, and necessary approvals are secured and works undertaken. This will also include working with AMG to book new events and to re-programme current bookings ready for the re-opening of St David's Hall.
35. A working group will need to be established between the Council and AMG to manage the overall process and facilitate the delivery of a solution for the re-opening of St David's Hall.
36. Upon AMG satisfying the conditions within the Conditional Agreement for Lease and the proposed transaction remaining viable, the Council will enter into the lease and business sale agreement with AMG to transfer the ongoing operation of St David's Hall to AMG.

37. Work-streams to determine the tax implications and appropriate structure of the transaction will need to be concluded.

Reasons for Recommendation

38. To establish a sustainable long-term future for St David's Hall, the National Concert Hall of Wales and to protect the delivery of the classical music/community programme.

Financial Implications

39. The report seeks approval for the Council to enter into a conditional agreement for lease subject to the conditions within it being satisfied. This approval would allow the Council to transfer St Davids Hall via a business sale agreement and a full repairing and insuring 45-year property lease with AMG as tenant for the operation of the building as an independent commercial enterprise. Entry into the business sale agreement and associated lease would be conditional on AMG receiving viable planning permission and listed building consent for the required works to the roof and other works to the stalls area. **Confidential Appendix 3** sets out the draft detailed terms for the lease and an associated business sale agreement.
40. The report also sets out the outcome of the intrusive surveys of the roof of St David's Hall, which has now confirmed the entire roof will need to be replaced to ensure a long-term solution is provided for the building to allow St David's Hall to operate as a venue. As reported previously, the replacement of the roof and other issues relating to the fabric of the building far exceeds the available capital budgets within the Council's programme.
41. Subject to the conditions being met, the lease as it is currently drafted would require no Council capital investment, no future buildings liability, and no committed annual revenue payments or subsidy to the new tenant. The offer also provides for the continuation of the classical programme requiring no on-going contribution from the Council.
42. It was previously reported that all staff associated with St David's Hall would transfer to AMG under the TUPE regulations. However, the closure of St David's Hall whilst a solution for the roof is developed, agreed, and delivered will have implications for the staff currently employed at St David's Hall.
43. The timelines in the report outline the potential for a significant period before the unconditional lease becomes active. During this period the Council will continue to be liable for the staffing and premises costs of the building. The current staffing cost for permanent employees (excluding agency staff) at St David's Hall is circa £1.5m per annum and the premises costs is circa £600k. If the hall is closed for an extended period, and no income from shows or hires is generated as this report suggests is likely, this would be the minimum annual cost to the Council until either the building is re-opened, and normal operations can resume or the transfer to AMG is concluded.

44. Promoters have indicated a willingness to work with the Council and AMG to reschedule and postpone performances to a later date, in order to facilitate all required works to be completed. There remains a risk that this may not be the ongoing case should the building remain closed for an extended period leaving the Council open to potential claims for compensation.
45. There may be offsetting premises savings that could be realised for reduced utilities and rates during this period. These variables will need to be worked through over the coming months to fully understand the financial impact of the proposals.
46. Given the likely extended timescales involved, the Council will now consult with all employees currently employed at St David's Hall and the appropriate representatives of such employees in relation to potential redeployment / voluntary redundancy / redundancy measures to best mitigate the costs identified above.
47. Redundancy and all expressions of interest will need to be considered on a case-by-case basis to ensure that there is an affordable and rational business case for release including any ongoing Pension Fund implications. Also, consideration will need to be given to any requirement to retain staff on a short-term basis to support and finalise the proposed transfer arrangements. The financial impact of these proposals would need to be worked through in more detail once the staff consultation is concluded and further information is available.
48. Considering the risks previously identified with the roof have now solidified / worsened, the Council will still need to be satisfied that any changes to the TUPE / Employee / Pension Fund implications set out in the report, or any obligations regarding the value of any assets transferred under the business sale agreement, remains consistent with the overall best value rationale as demonstrated in previous reports.
49. Further consideration will need to be given to the legal, procurement, VAT, and tax implications of the proposals as the transfer documentation is finalised in order to ensure that the structure of any final contract sufficiently protects the Council's interests.

Legal Implications

50. Legal advice in relation to the proposed transaction is set out at **Confidential Appendix 3**.
51. Section 123 of the Local Government Act 1972 provides the Council with power to dispose of land "in any manner they wish", provided that best consideration is obtained for disposal of any interest for a term exceeding 7 years. Disposal of an interest in land for a term exceeding 7 years for a consideration less than the best that can reasonably be obtained requires the consent of the Welsh Parliament, unless the disposal falls within the NAFWC

41/2003 Local Government Act 1972: General Disposal Consent (Wales) Order 2003.

52. The Council has obtained professional advice from an independent surveyor on the best consideration duty **Confidential Appendix 3**. In conclusion, the independent surveyor stated that:

“AMG’s offer when balanced against the liabilities and costs currently facing the Council, clearly demonstrates best consideration for the Council...”

53. The surveyor’s advice was received prior to the Council receiving advice from its consulting engineers that the venue needed to be shut due to the high-level risk associated with the roof. The requirement to repair the roof was already identified within the surveyor’s report and accounted for by AMG in their offer. The effect of the crystallisation of risk brings forward the need to repair and replace. Costs of expediting the repairs are likely to be higher than costs associated with repairs to be undertaken over a period of time, and this change in circumstance is therefore unlikely to reduce the costs for the repair and replacement programme used in the assessment.
54. The Council has also obtained two opinions from King’s Counsel addressing issues of procurement law, the best consideration duty under section 123 LGA 1972, and on subsidy control set out at **Confidential Appendix 3**. This which was first presented to Cabinet at the meeting of 13 July 2023. Counsel’s advice contains various recommendations as to points to be addressed before the transaction is finalised. **Confidential Appendix 3** sets out the points to be addressed and the steps taken by the Council.
55. Cabinet will need to remain satisfied, with reference to the advice received from the independent surveyor, from King’s Counsel (and subject to satisfactory resolution of the points to be addressed in King’s Counsel’s advice), and in light of the closure of the venue and need for urgent repairs and replacement of the roof to allow the venue to operate (and the increased upfront cost that AMG will need to bear in relation to such repairs),, that the disposal by way of a 45 year lease to AMG continues to meet the best consideration duty.
56. In coming to its decision, Cabinet needs to ensure that it acts in accordance with its fiduciary duty to local residents and taxpayers.
57. Cabinet must also have due regard to the Council’s public sector equality duty pursuant to the Equality Act 2010 (including specific Welsh public sector duties). An Equalities Impact Assessment (EIA) has been undertaken and was originally provided to Cabinet at its meeting of 13 July 2023, and is attached as **Appendix 4**.
58. The Well-being of Future Generations (Wales) Act 2015 ("the Act") places a 'well-being duty' on public bodies aimed at achieving 7 national well-being goals for Wales — a Wales that is prosperous, resilient, healthier, more equal,

has cohesive communities, a vibrant culture and thriving Welsh language, and is globally responsible.

59. In discharging its duties under the Act, the Council has set and published well-being objectives designed to maximise its contribution to achieving the national well-being goals. The well-being objectives are set out in Cardiff's Corporate Plan 2023-26.
60. The well-being duty also requires the Council to act in accordance with the 'sustainable development principle'. This principle requires the Council to act in a way which seeks to ensure that the needs of the present are met without compromising the ability of future generations to meet their own needs. Put simply, this means that Council decision makers must take account of the impact of their decisions on people living their lives in Wales in the future. In doing so, the Council must:
 - Look to the long term;
 - Focus on prevention by understanding the root causes of problems;
 - Deliver an integrated approach to achieving the 7 national well-being goals;
 - Work in collaboration with others to find shared sustainable solutions; and
 - Involve people from all sections of the community in the decisions which affect them.
61. The Cabinet must be satisfied that the proposed decision accords with the principles above; and due regard must be given to the Statutory Guidance issued by the Welsh Ministers, which is accessible here:

<http://gov.wales/topics/people-and-communities/people/future-generations-act/statutory-guidance/?lang=en>
62. The Council has to be mindful of the Welsh Language (Wales) Measure 2011 and the Welsh Language Standards when making any policy decisions and consider the impact upon the Welsh language.

Employment law

63. The closure of St David's Hall whilst a solution for the roof is developed, agreed, and delivered and the fact that, at this point in time, the Council cannot guarantee that a viable solution can be found that will allow the building to re-open, has implications under employment law. The closure of the St David's Hall, as opposed to a transfer of the staff under TUPE, means that the Council may need to make the staff working at the Hall redundant unless it is possible to redeploy them elsewhere within the Council or otherwise avoid redundancies. Prior to any such decisions being made, the Council should consult with the appropriate representatives of the affected staff under s188 Trade Union Labour Relations (Consolidation) Act 1992 and follow a fair

process in relation to any redundancy proposals, including consulting with affected staff individually, to try to mitigate the need for any redundancies.

Property Implications

64. The Council is under an obligation - solely in its capacity as landowner and without prejudice to its capacity as planning authority – to provide reasonable co-operation to AMG to satisfy the conditions to the agreement for lease.
65. From exchange of the agreement, the parties will be bound to enter into the lease and business sale agreement following satisfaction of the conditions.
66. Save for the above, there are no substantial obligations on the part of the Council before completion of the Lease.
67. If the conditions are not satisfied within 12 months (subject to extensions to a maximum of 36 months from the agreement if a submitted planning application or appeal is pending final determination), either party may terminate the agreement and the transaction will not proceed.
68. Exchanging an agreement for lease will ensure that the parties are legally bound to complete the lease and business sale agreement subject to the conditions above being satisfied.
69. Without an agreement for lease, either party could withdraw from the transaction with no notice or reason.
70. Without an agreement for lease, AMG may be unlikely to proceed without assurance that the additional works required are viable.

HR Implications

71. In July 2023, as outlined in paragraph 5 of this report, Cabinet agreed that negotiations could conclude with the AMG group to complete the lease and business sales agreement and authorised the transfer of employees from Cardiff Council to the AMG group under the Transfer of Undertaking (Protection of Employment Regulations 2006, as amended. (TUPE).
72. The Council made the decision to close St. David's Hall during September 2023 following receipt of advice in relation to RAAC being present at the venue which represented a critical health and safety risk.
73. Following the closure of St. David's Hall, some employees have continued to undertake their roles through hybrid working, whilst other employees have been working at alternative venues such as County Hall thus ensuring business continuity to members of the public and external companies. Casual workers have been offered alternative work opportunities at various venues which has reduced the need to engage agency workers.

74. The outcome of the surveys confirm that the roof of St. David's Hall will need to be replaced. This would have significant implications for employees as the Council is not able to inform employees when the building would likely re-open and become operational as a venue.
75. As outlined in the financial implications, the timelines indicate the potential for a significant period before the unconditional lease becomes effective and during this time the Council will continue to be liable for employee salary costs. Furthermore, as the venue will remain closed with no services taking place, there will be a need for employees to be gainfully employed potentially carrying out alternative duties.
76. The employment law aspects are covered at paragraph 63 of this report. As St. David's Hall will remain closed for an unspecified period of time, whilst it is possible for TUPE to apply in certain circumstances where there is a temporary cessation of activities of the undertaking; given the number of uncertainties and variables and the length of the potential closure with no business activity undertaken, it would be unlikely that TUPE would apply but this would be fact dependent on the circumstances and could only be tested through legal routes.
77. Given the impact of the uncertainty of the future opening and operation of St. David's Hall on employees and the ongoing salary liabilities to the Council whilst the venue is closed, the Council should undertake a period of consultation with employees and trade unions in respect of potential redundancy risks as outlined in paragraph 63 of this report. The Council will make every effort to mitigate the need for any redundancies and will in the first instance seek expressions of interest from employees in Voluntary Severance and will also seek to redeploy employees to alternative roles within the Council via the Corporate Redeployment Scheme. Employees who are seeking redeployment will remain on the redeployment register for a period of 12 weeks whilst suitable alternative employment opportunities are sought. At the end of the 12-week period, should the Council not be able to secure alternative employment, employees will be made redundant and would receive redundancy payments based on the Council's enhanced redundancy payments scheme.
78. As outlined in paragraph 47 of the financial implications contained in this report, all expressions of interest in Voluntary Severance would need to be considered on a case-by-case basis considering any pension fund implications.
79. It is essential that employees are fully briefed, consulted and supported throughout the formal consultation process.
80. The trade unions, employees and agency workers have been briefed on the recommendations set out in this report. Should Cabinet agree to the recommendations, a formal consultation period will commence under s188 Trade Union Labour Relations (Consolidation) Act 1992.

RECOMMENDATION

Cabinet is recommended to:

- 1) Delegate authority to the Director of Economic Development in consultation with the Cabinet Member for Culture, Parks and Events, the Section 151 Officer, and the Legal Officer to conclude negotiations with AMG and other relevant stakeholders to:
 - a. Finalise and enter into a Conditional Agreement for Lease with AMG on the basis of the principles set out in the draft Conditional Agreement for Lease set out at **Confidential Appendix 3**;
 - b. Enter into the lease and associated documents as set out at **Confidential Appendix 3** upon satisfaction of the conditions within the Conditional Agreement for Lease;
 - c. Complete the business sales agreement with AMG for St David’s Hall based on the principles set out in the draft business sales agreement attached at **Confidential Appendix 3** upon satisfaction of the conditions within the Conditional Agreement for Lease;
- 2) Note the continued closure of St David’s Hall and the associated consequences set out in this report until AMG satisfy the conditions within the Conditional Agreement to Lease.
- 3) In light of the above, it is unlikely that all employees will transfer to AMG under the Transfer of Undertaking (Protection of Employment Regulations 2006) as envisaged in the July 2023 Cabinet report. As a result, to note the Council’s proposed staff engagement strategy to manage the closure of St David’s Hall as set out in this report.

SENIOR RESPONSIBLE OFFICER	Neil Hanratty Director of Economic Development
	Date

The following appendices are attached:

Appendices

Appendix 1 - Visual Images of RAAC Planks

Appendix 2 - Engineers Report

Confidential Appendix 3 - Legal Advice & Documents

Appendix 4 - Single Impact Assessment

Overview of RAAC Planks

What is RAAC?

Re-inforced Autoclaved Aerated Concrete (RAAC) is a form of lightweight concrete that was used in roof, floor, cladding and wall construction in the UK from the mid-1950s to the early 1980s. It was a popular material at this time due to its low cost and a lightweight alternative to conventional reinforced concrete, making it a preferable choice as a roofing material. Often formed into pre-cast planks, RAAC has a bubbly appearance, creating a material of low density and weight, strengthened from within by steel wire or reinforced metal rods:

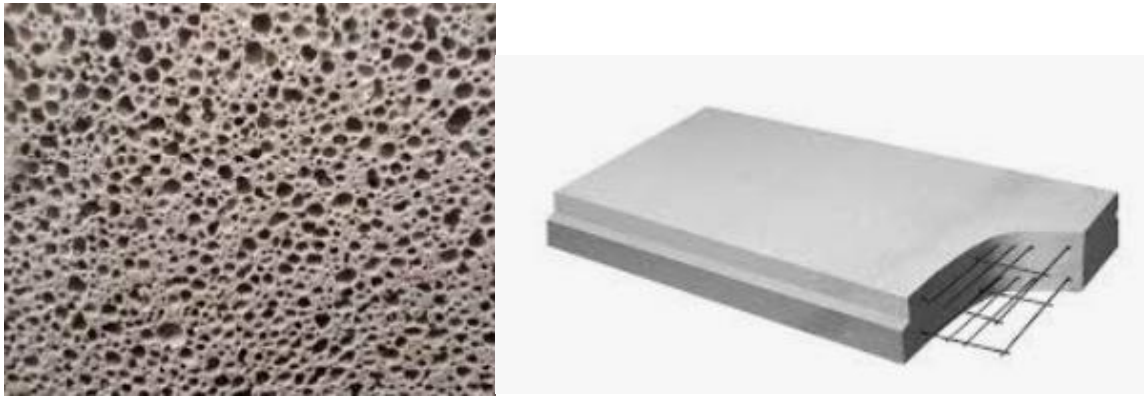

The durability and structural integrity of RAAC over time has proven to be limited, with an approximate lifespan of 30 years. The material has a lower structural loading capacity than other concrete materials and is porous, thus prone to moisture absorption. This can lead to cracking and corrosion of the metal reinforcement within, causing it to weaken. Continued deterioration has in some buildings lead to collapse.

IStructE & Health & Safety Executive guidance on RAAC

Following instances of roof collapse, with no warning, to buildings containing RAAC this year, IStructE (The Institution of Structural Engineers) and the Health & Safety Executive issued revised guidance for the management of the material. The guidance advises that organisations should identify RAAC in buildings and seek specialist advice to assess it and develop a management plan (Source: [Managing risk from reinforced autoclaved aerated concrete \(RAAC\) - Education - HSE](#)) and to refer to further guidance as outlined on the Institution of Structural Engineers website www.istructe.org

RAAC deterioration

Visual inspections may identify cracking and deflections to exposed and visible areas of RAAC, however, an intrusive survey carried out by a professional structural engineer is recommended to be the only effective method of gaining a detailed insight into condition. The following images illustrate deterioration within RAAC planks that would not be identified from a visual inspection from the underside:

PLEASE NOTE - These are NOT images of RAAC at St. David's Hall



RAAC at St. David's Hall

The roof at St. David's Hall is constructed of a large, clear-span steel framed mansard roof together with terraced flat roofs. This is surrounded by a vertical mansard with a lead cladding.

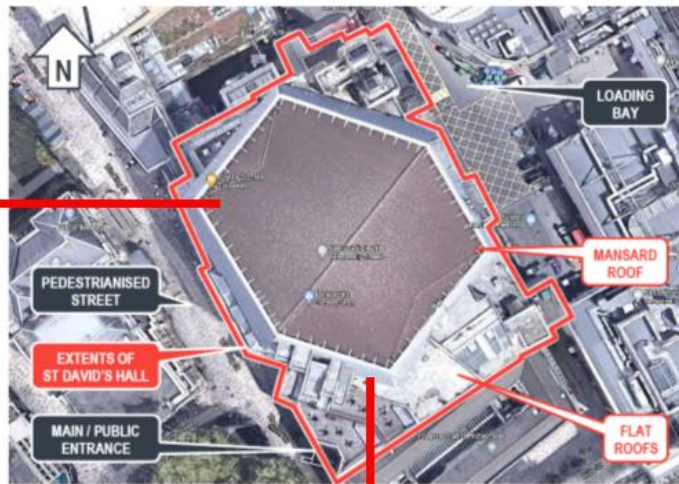

Sloped bitumen covered membrane over the RAAC plank roof



Vertical lead clad mansard surrounding the roof area, visible from street level

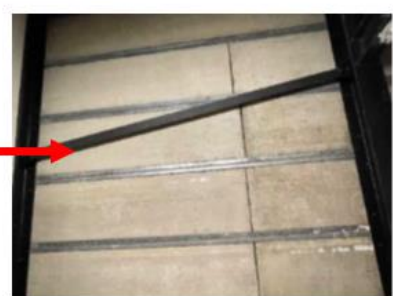

Woodwool concrete interior of the vertical lead clad mansard

The below diagram illustrates a cross section of the Mansard roof which contains 938 RAAC planks overlaid with a bitumen covered roof membrane:

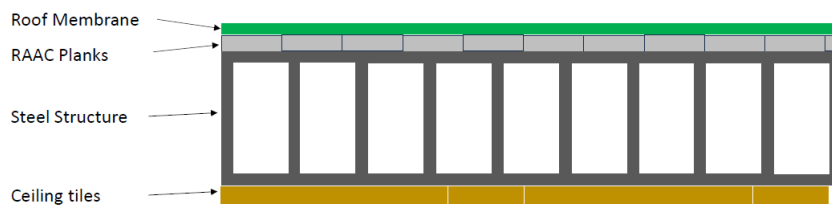

The below images show the space between the ceiling and roof at St. David's Hall and a closer view of a section of RAAC planks taken from below looking upwards:





Cardiff County Council

ST DAVID'S HALL - RAAC ROOF PLANK SURVEY







Cardiff County Council

ST DAVID'S HALL - RAAC ROOF PLANK SURVEY

Page 39

TYPE OF DOCUMENT (VERSION) PUBLIC

PROJECT NO. 70086249

OUR REF. NO. WSP-XX-XX-RP-S-000001

DATE: OCTOBER 2023

WSP

1 Capital Quarter

Tyndall Street

Cardiff

CF10 4BZ

Phone: +44 2920 769 200

WSP.com

QUALITY CONTROL

Issue/revision		First issue			
Remarks					
Date		October 2023			
Prepared by		Helen Phillips/ Stuart Renshaw			
Signature					
Checked by		Chris Pembridge			
Signature					
Authorised by		Matthew Palmer			
Signature					
Project number		70086249			
Report number		WSP-XX-XX-RP-S-000001			
File reference					



CONTENTS

	EXECUTIVE SUMMARY	2
1	INTRODUCTION	3
2	RAAC OVERVIEW	4
3	RAPPEL SURVEY DATA	6
4	SURVEY SUMMARY	12
5	REMEDIAL OPTIONS	13
6	CONCLUSION	14

APPENDICES

APPENDIX A

RAPPEL SURVEY DATA - END BEARING MEASUREMENTS

APPENDIX B

RAPPEL SURVEY DATA – INTRUSIVE SITE INVESTIGATIONS

EXECUTIVE SUMMARY

WSP originally prepared an assessment report on the condition of the RAAC Panels in the roof of St David's Hall in 2021. This initial inspection of the RAAC Panels presented a technical risk profile as regards failure and made recommendations for ongoing assessment and remedial measures. An important element to note in that report was around the inability to investigate the end supports of the RAAC Panels due to the access available.

This report was prepared based on BRE and the IStructE published guidance at that time.

In April 2023, IStructE published new guidance for the Assessment of RAAC panels. It is this new guidance that has likely changed the positioning around assessment of RAAC Panels and the HSE Statements / Guidance, etc.

The greatest change in the new guidance is that it requires more stringent and indeed intrusive investigation of the end bearing condition.

The fact that this end bearing was unable to be investigated on this project has meant that the conclusions of the original 2021 report would now fall outside current guidance, albeit that the risks presented were based on an inability to inspect the end bearing condition.

The 6 monthly assessments as recommended in our original report have been undertaken and no significant deterioration in the condition of the RAAC panels has occurred.

The new April 2023 guidance required Intrusive Investigation into the end bearing condition of the panels. This is because hidden failures has been identified due to the end condition. An example of such a 'hidden' failure is shown in the image below:

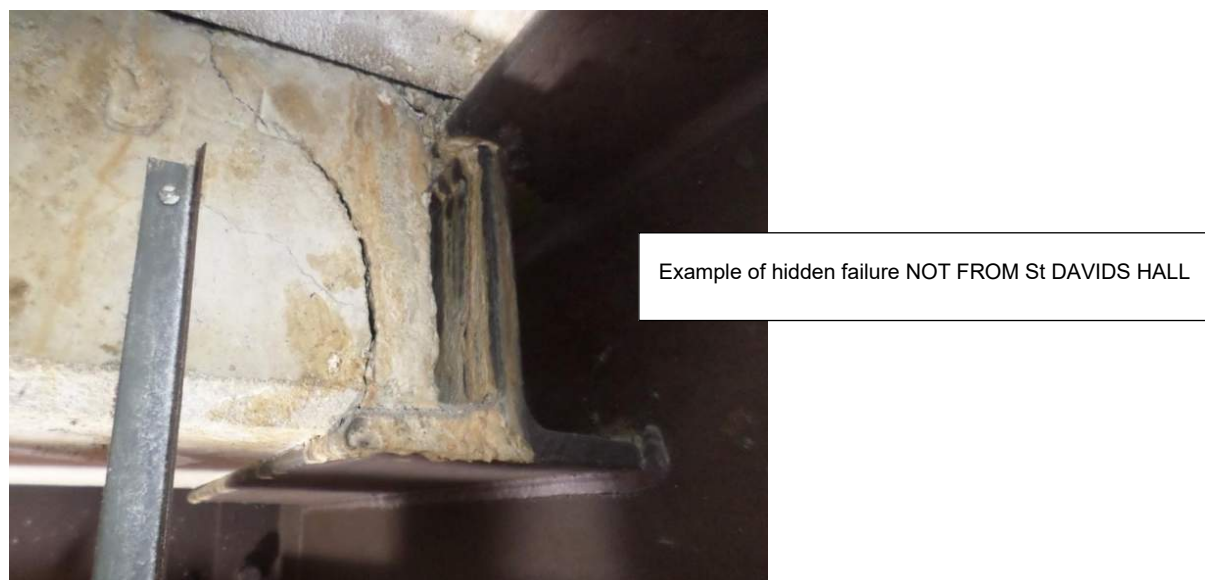

This Report presents the results of this Intrusive Investigation.

Two aspects have been investigated:

- The length of bearing present
- The presence of longitudinal and transverse reinforcement over the bearing.

The results of the investigation presented herein are summarised as follows based on interpolation of the number of investigation points over the whole number of RAAC Panels:

Red – End bearing checks undertaken by Rappel highlight a large majority of bearings <75mm, with the average bearing length found to be 62mm. Approximately 279 No. readings were found to be between 45mm ≤ X <75mm, which equates to 66% of readings taken.

Red (critical) – As identified on the intrusive surveys, 1 out of the 10 survey points were found to lack required transverse reinforcement, equating to 10%. Extrapolating this value, we would therefore anticipate 93 No. panels to not have a transverse bar over the support over the entirety of the site.

Red (critical) – 49 No. end bearing measurements were found to be <45mm, which equates to 12% of readings taken. Due to these being below the original design criteria (45mm), they are to be classified as red (critical).

It can be Interpolated that:

- 10% or 93 No of the panels will not have transverse reinforcement present over the bearing length making 10% of the panels RED – CRITICAL RISK on this point.
- The maximum bearing length encountered was 62mm which is less than the 75mm guidance making the average condition RED - HIGH RISK
- End bearing checks identified 279 No readings between 45mm and 62mm – RED – HIGH RISK
- Longitudinal reinforcement was found to be present in all test locations.
- 49 No End bearing measurements were found to be less than 45mm (the original design criteria), this is approximately 12% - RED – CRITICAL RISK

Therefore, the overall risk category for the roof is **RED – CRITICAL RISK**.

The IStructE Guidance therefore requires, urgent remedial works. This may include taking out of use or temporary propping to allow safe ongoing use of the building. The consideration of this needs to be assessed through Health Safety & Operational risk assessment. This will need to take into account insurers, promoters and other user groups.

This report has identified a form of urgent remedial measures. This would entail significant access to the roof areas either through roped access or scaffolding.

Given the guidance and condition of the planks and particularly the lack of original design end bearing replacement of the planks should be considered as a requirement subject to replacement.

In considering structural components to replace the RAAC panels, consideration needs to be given to the self-weight / dead loading of the replaced element and the acoustic performance of the theatre space in terms of mass and surface hardness.

NEXT STEP

The duty holder of the building should next undertake a risk assessment of the building considering the risks identified in this report, the use of the building and the published guidance from the HSE.

In addition, we are aware that the presence of RAAC Panels can affect the insurances available to operate buildings. This should be considered by the building owner and operator.

1 INTRODUCTION

As a result of recent changes to the advice on RAAC Panels in public buildings, issued by the Health and Safety Executive, Cardiff Council has instructed WSP to undertake further exploratory works to explore the condition of the RAAC panels at St David's Hall and mitigate any further risk in all instances of RAAC construction. During September to October 2023, intrusive investigation has been undertaken by Rappel (a rope access contractor) to identify the reinforcement and bearing length of the panels in accordance with the latest Institution of Structural Engineer's guidance documents.

This report aims to provide a description of the survey process undertaken, a summary of the intrusive investigation findings and a description of possible remedial options which should be considered to ensure safety of the building. The report will identify the risks presented by the presence of the RAAC Panels, their condition and characteristics identified during this Intrusive Investigation. This risk categorisation will allow the building duty holder to undertake a risk assessment on the next actions necessary to ensure the safety in operation of the building.

Please note: Rappel had previously undertaken a visual survey of the roof space, focused on the perimeter, where they found approximately 100+ defects such cracks to the ends of the panels as well as previous builders works holes, etc. This investigation was carried out on behalf of Live Nation by Buro Happold as part of their pre-acquisition surveys. The findings in this WSP report are independent of Live Nation surveys.

2 RAAC OVERVIEW

The following section provides an overview of the historic use of RAAC panels, its structural properties, potential defects, and previous investigations that have been undertaken,

2.1 MATERIALS, PROPERTIES AND CHARACTERISTICS

RAAC planks are believed to have first been used in 1929 and are understood to have been used in the UK since the late 1950s. They were widely used for roofing but also for walls, partitions, and floors until 1982 when production in the UK ceased, reportedly for commercial reasons.

The planks were made from a raw slurry comprising lime and cement mixed with fine grained sand and combined with admixtures. Air or gas was then introduced into the slurry, and the resulting foam-like liquid poured into a mould and allowed to take on an initial set, after which the large block was cut to size and steam cured under high temperature and pressure. Individual planks were then cut from the large block.

The resulting planks are of relatively low density, variable between 300-1,000kg/m³, but more typically 400-700 kg/m³.

Figure 1 - Images showing physical properties of RAAC panels



The planks contain embedded steel to improve the flexural and shear capacities, which are low in unreinforced AAC blocks. The reinforcement is typically light gauge steel wire but in later examples reinforcement bar is used.

Unlike normal high-density reinforced concrete there is no appreciable bond between the steel and the AAC: transfer of flexural tension is achieved by transverse steel near the end of the planks. The transverse steel is welded to the longitudinal tension steel to aid transfer of forces into the AAC.

The automatic protection offered to embedded steel in normal reinforced concrete is absent in RAAC, therefore the steel is chemically coated to prevent corrosion.

2.2 HISTORIC RAAC DEFECTS AND PREVIOUS INVESTIGATIONS

In the early 1990's general concerns were raised over the structural adequacy of RAAC planks by some structural engineers and some national/local government bodies, particularly regarding planks made before

1980. These concerns were based on reports of cracking to the soffit of panels, excessive deflection, rusting of embedded reinforcement leading to cracking/spalling, and lack/loss of diaphragm action of roof plates made from RAAC panels. The 'typical' cracking exhibited by planks showing a sign of distress recorded by BRE was a pattern of roughly parallel fine/hairline transverse cracking at fairly regular intervals along the span – see figure 1.

The Building Research Establishment (BRE) were asked to advise on reported defects where the long-term deflections of flat roofs built from RAAC planks had caused serviceability issues such as water ponding and consequent increase in load from retained water, distress to applied membranes leading to water ingress and corrosion of embedded reinforcement. However, BRE recognised that there was no objective guidance on the structural capacity of deflected/cracked planks, their safety, or their likely long-term performance. As a consequence of this recognition BRE devised a series of tests commencing in 1991.

The 1991 tests were on panels removed from a housing development after some 20 years' service and which showed extensive hairline cracking to the soffits. In summary, these tests convinced BRE that although visibly deflected and cracked the panels when loaded to failure gave adequate warning of imminent failure via "local crushing, horizontal delamination and extensive cracking of the AAC panel in the vicinity of the supports". The tests noted that the deflections at ultimate load (i.e., the load at which failure occurred) were in excess of 1/50th of the span. BRE also reported that for the tested planks there was no deficiency in the AAC matrix, and that corrosion of embedded steel had not led to appreciable losses of steel section.

A second set of 1995 tests were carried out on new panels made in Europe. BRE noted that some panels lacked the transverse reinforcement at the ends necessary for load transfer from the longitudinal steel, and that as a consequence failure occurred at the ends of such defective planks. BRE concluded that correctly manufactured planks i.e., those with transverse reinforcement at the ends – were likely to give warning of collapse by cracking and spalling of the AAC, and that failure would be ductile giving ample warning of failure via appreciable deflection prior to collapse. It should be noted that BRE found that the average span to deflection ratio at failure was about 71, the range being 50-93.

A further point to note from the second 1995 tests is BRE's observation that creep deflection is not proportionally related to elastic deflection. This means that whereas instantaneous deflection proceeds in a linear-elastic manner proportional to load (up to failure), creep deflection is accelerated the more load is applied.

BRE believe that the tendency toward creep deflection is caused by the low modulus of the RAAC, in some cases lower than the design assumptions of the manufacturers, coupled to yield of AAC in the zone of transverse anchorage in the reinforcing bars and bond slip between reinforcing bars and AAC. BRE also noted that the deflection performance of some older RAAC panels worsened with time, possibly due to the formation of micro-cracks in the RAAC.

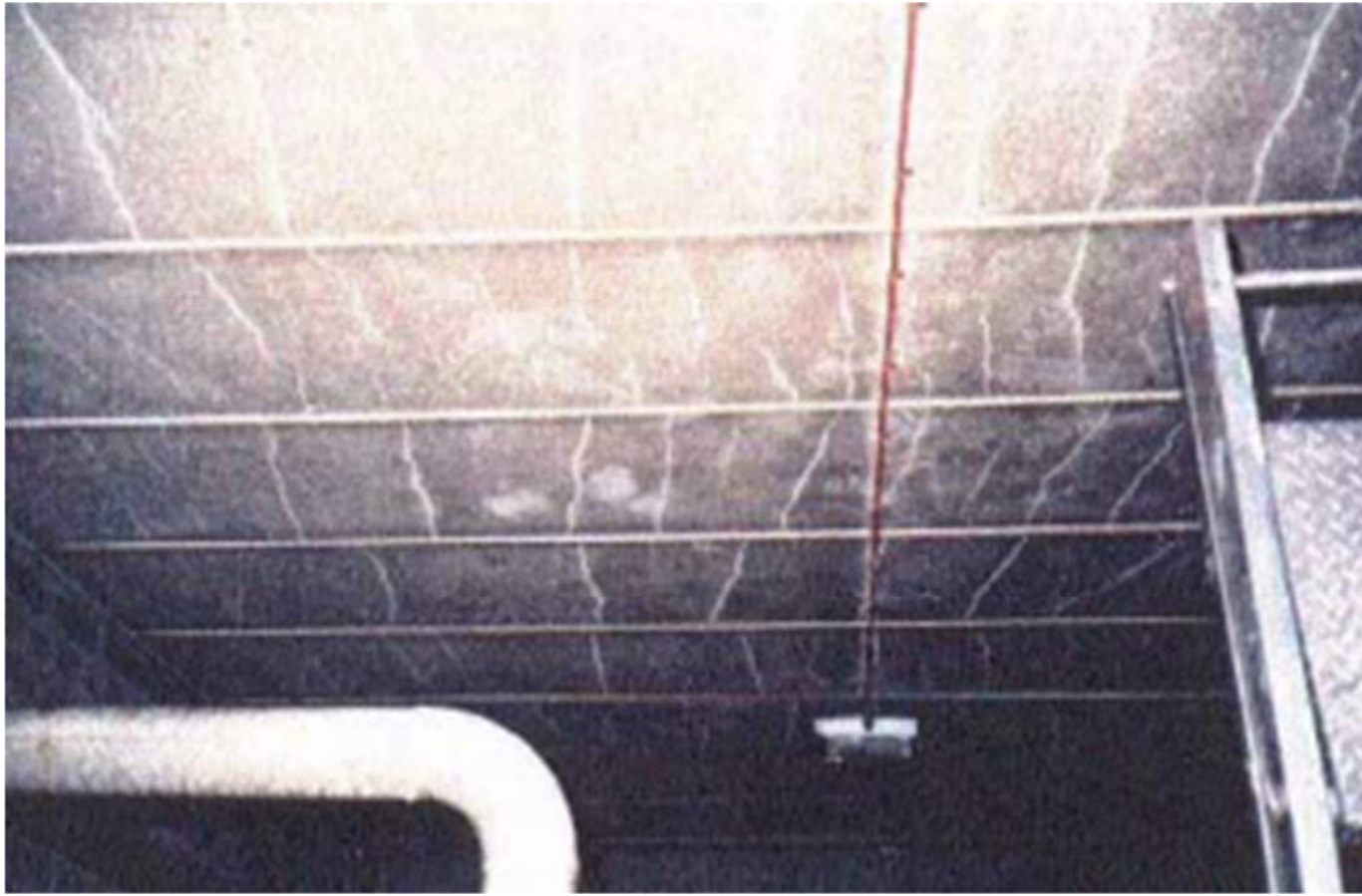

Figure 2 – Transverse cracking in a pre-1980 RAAC plank

BRE make the following recommendations for maintenance of RAAC planks over 20 years old:

- Reduce loading on RAAC roofs.
- Ensure all waterproof membranes are in good condition.
- Keep records of deflections of RAAC planks and inspect regularly.
- Inspect annually if the structure is in poor condition, deflections are greater than 1/150th of the span, or the planks are in a moist environment or exhibit rust staining.
- 5 yearly inspection intervals should be sufficient if there are no other problems, the structure is in good condition and deflections are less than 1/200th of the span.

In 1999 the Confidential Reporting on Structural Safety panel (SCOSS) reported on RAAC planks. They quoted from the BRE tests noted above and went on to concur with BRE's general conclusion that "pre 1980 RAAC planks do not appear to generally to present a safety hazard as they gradually deteriorate over time". However, the SCOSS report discusses concerns raised over the suitability of RAAC planks for permanent use. With reference to this particular concern, the then Department of the Environment, Transport, and the Regions (DETR) had discussions with the manufacturers and according to SCOSS following these discussions references to RAAC were removed from design standards and codes current and in preparation at the time. The precise reason for removal of these references is not stated, but the SCOSS commentary makes clear a link between concerns over structural safety of RAAC planks and the observation that mention of RAAC planks in design codes gives the material "an unjustified respectability, 'the impression that it can be used for permanent structures and that safety is in question".

2.3 FURTHER SCOSS REPORTING

In late 2018 a RAAC panel within a school collapsed suddenly which gave rise for the latest SCOSS report published in May 2019. The 'Failure of Reinforced Autoclaved Aerated Concrete (RAAC) Planks' report written by the Standing Committee on Structural Safety (SCOSS). The SCOSS report referred to above outlines details of a sudden collapse and a number of warning signs to be aware of that indicates panels may be near failure.

These are as follows:

- Significant cracking and disruption of the planks near the support.
- Any planks that have deflected more than 1/100 of the span, or a significant number of planks have deflections approaching this magnitude.
- Several of the planks having very small bearing widths (less than 40mm).
- The roof has been resurfaced since original construction; this is particularly an issue if the load has been increased or the resurfacing has a black finish, and the previous surface did not.
- There is significant ponding on the roof.
- The roof is leaking or has leaked in the past.

The recommended maximum deflection limits for the RAAC panels as defined in the above reports is 1/100th of the span.

Following shear failures in previously thought to be good condition RAAC planks the IStructE issued updated guidance - *Reinforced Autoclaved Aerated Concrete (RAAC Investigation and Assessment – Further guidance, IStructE, April 2023*.



Shear failure of RAAC plank – **NOT ST DAVIDS HALL**

3 RAPPEL SURVEY DATA

Rappel undertook intrusive survey investigations at St David's Hall between 25th September – 6th October 2023 under the instruction of WSP. The main aim of the investigations was to:

- Confirm end bearing length – Short bearing lengths increase the panels' vulnerability to vertical shear failure, therefore is critical to assess the structural integrity of the panels. At St David's Hall, supporting steel flanges are typically 146mm wide.

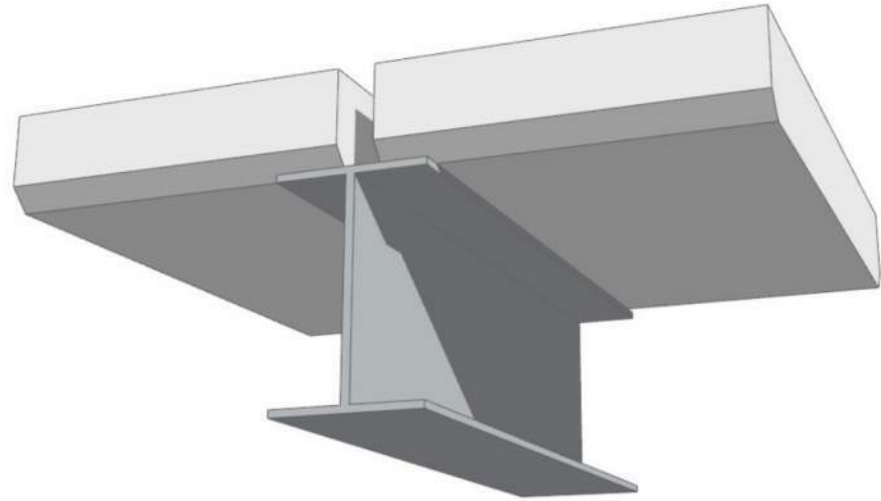

Sub-standard bearing on 100mm beam

- Identify position of steel reinforcement (intrusive investigation) – it has been evidenced that longitudinal reinforcement has sometimes been stopped short of the end bearing during installation. Where lack of continuity of the bars exists, there is a reduction in vertical shear capacity of the planks. Therefore, understanding the position of the rebar in the plank is key to understanding the robustness of the panels and their assumed capacity. This intrusive type of survey will also confirm the condition of the reinforcement and if it has been subject to any corrosion.

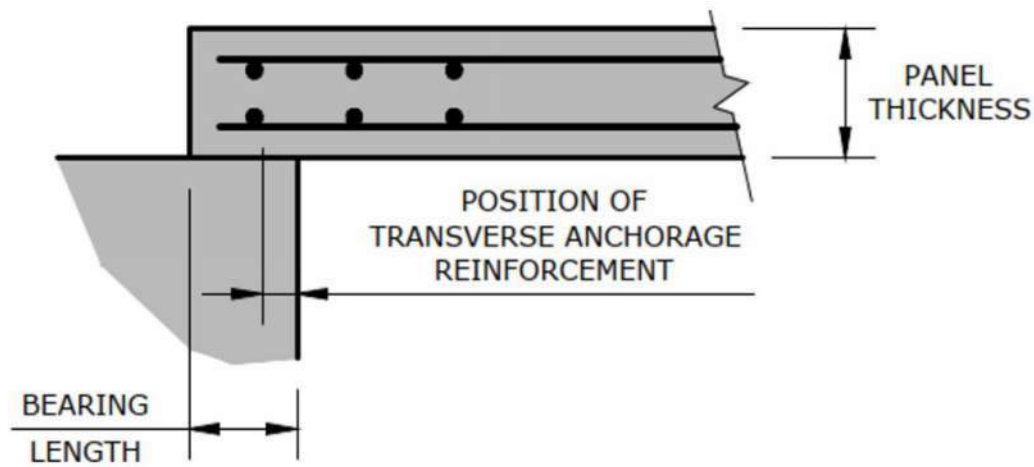

Figure 2 – End bearing configuration

3.1 METHOD OF INVESTIGATION

Measurements to confirm the RAAC plank end bearing over the steel beam flange, was undertaken using standard hand tools (small areas at a time). A steel measurement tool was used to hook to the rear of the plank via the 'V' grooved channel between planks, as highlighted in Figure 3-1. This method of measurement was limited to areas which were not obstructed by debris or infill between adjacent planks.

Measurements to confirm the presence and position of rebar were carried out by coring at the end bearing of the planks. Cores were as small as possible to minimise any damage to the existing RAAC panels.

Approximately 931 planks are present in the roof at St David's Hall, with their layout highlighted in Figure 3-2. This key plan identifies the locations of end bearing measurement (green) and intrusive investigation (red) carried out by Rappel.

Figure 3-1 - Current roof planks and steel purlin arrangement, view from underside of structure.

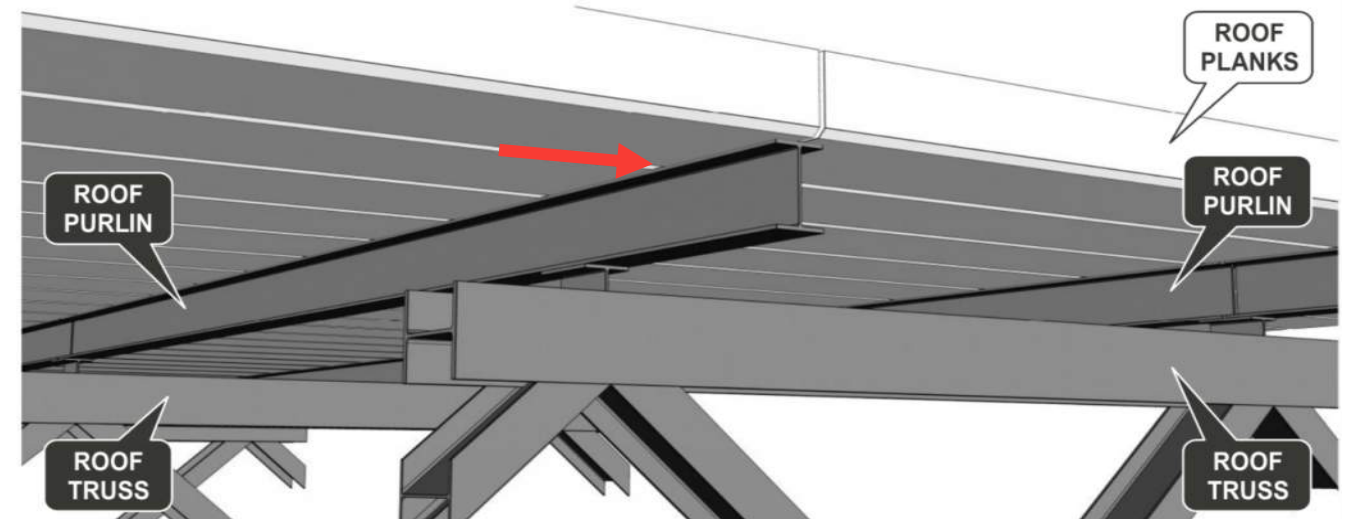
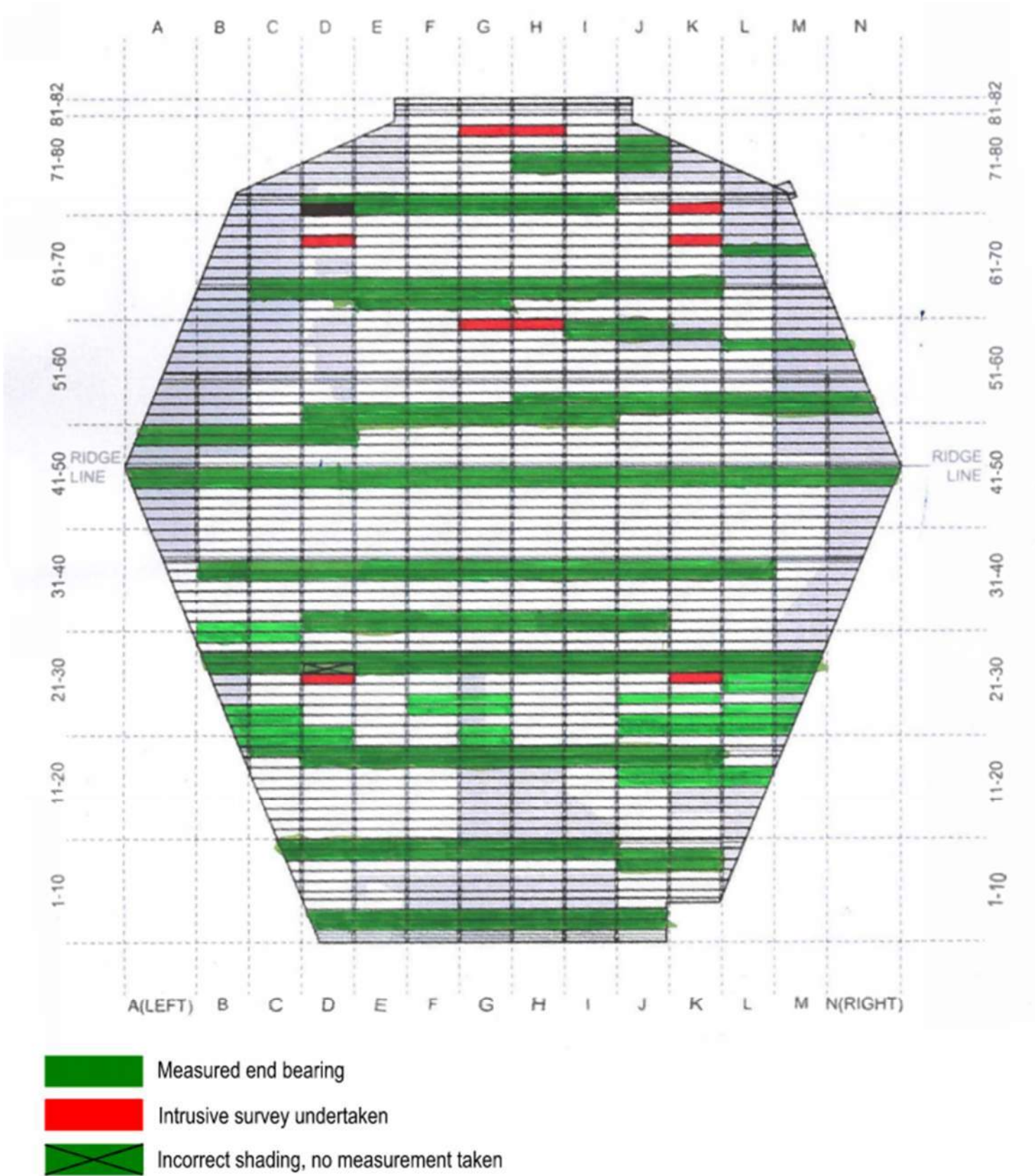

Figure 3-2 - St David's RAAC panel key plan



3.2 FINDINGS

3.2.1 END BEARING LENGTHS

A total number of 425 end bearing tests were undertaken by Rappel, with 38 of these unsuccessfully measured due to the presence of debris or infill of the 'V' grooved channel between planks.

As a result, out of CIRCA 931 planks at St David's, CIRCA 271 were tested at one of its ends to provide an end bearing measurement, covering approximately 29% of the total planks on site.

A summary of all end bearing lengths collected on site can be found in Appendix A and are tabulated according to the key plan in Figure 3-2. These values have been plotted independently and colour coordinated to highlight the range of end bearing across the site (Figure 3-3).

Minimum end bearing

Analysis of results at St David's Hall found the minimum measured end bearing length to be CIRCA 25mm in 3no. locations.

During the RAAC panel construction period (CIRCA 1950-1980), design codes of that time highlight an allowance of 45mm end bearing lengths for roof panels. In practise, construction tolerances could have resulted in further reduced bearing lengths. However, due to the limited access at time of survey an unseen broken corner to a plank may lead to an end bearing measured length as small as 25mm at the V grove location.

As per guidance provided in *Reinforced Autoclaved Aerated Concrete (RAAC Investigation and Assessment – Further guidance, IStructE, April 2023)*, a minimum bearing length of 75mm is now considered to be the standard minimum. Any bearing <75mm is considered substandard and presents an unacceptable risk for which remedial actions are recommended.

Maximum end bearing

Analysis of results found the maximum measured end bearing length to be 92mm.

A total number of 59 end bearing tests are ≥ 75 mm and are therefore deemed satisfactory in accordance with IStructE recent guidance.

Average end bearing

Over all measurements taken, the average end bearing was 62mm.

3.2.2 INTRUSIVE REINFORCEMENT INVESTIGATION

A total number of 10 intrusive investigations were conducted on site to examine the presence of rebar at the end bearings. All findings have been sketched and displayed in Appendix B, highlighting the end bearing length and position of transverse reinforcements at one of its ends. These figures have also been tabulated with relevant images on the following page.

From the 10 No. intrusive investigations we can conclude the following:

- 1 location has a transverse bar short of the bearing area & a longitudinal bar.
- 9 locations have a transverse bar over of the bearing area & a longitudinal bar.
- Plank bearing on the top flange of the UB ranges from 46mm to 84mm but is typically 68mm.
- Reinforcement appears in a good condition with no signs of corrosion.



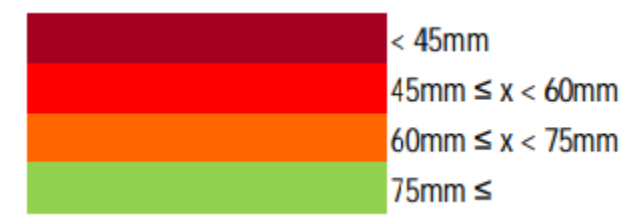
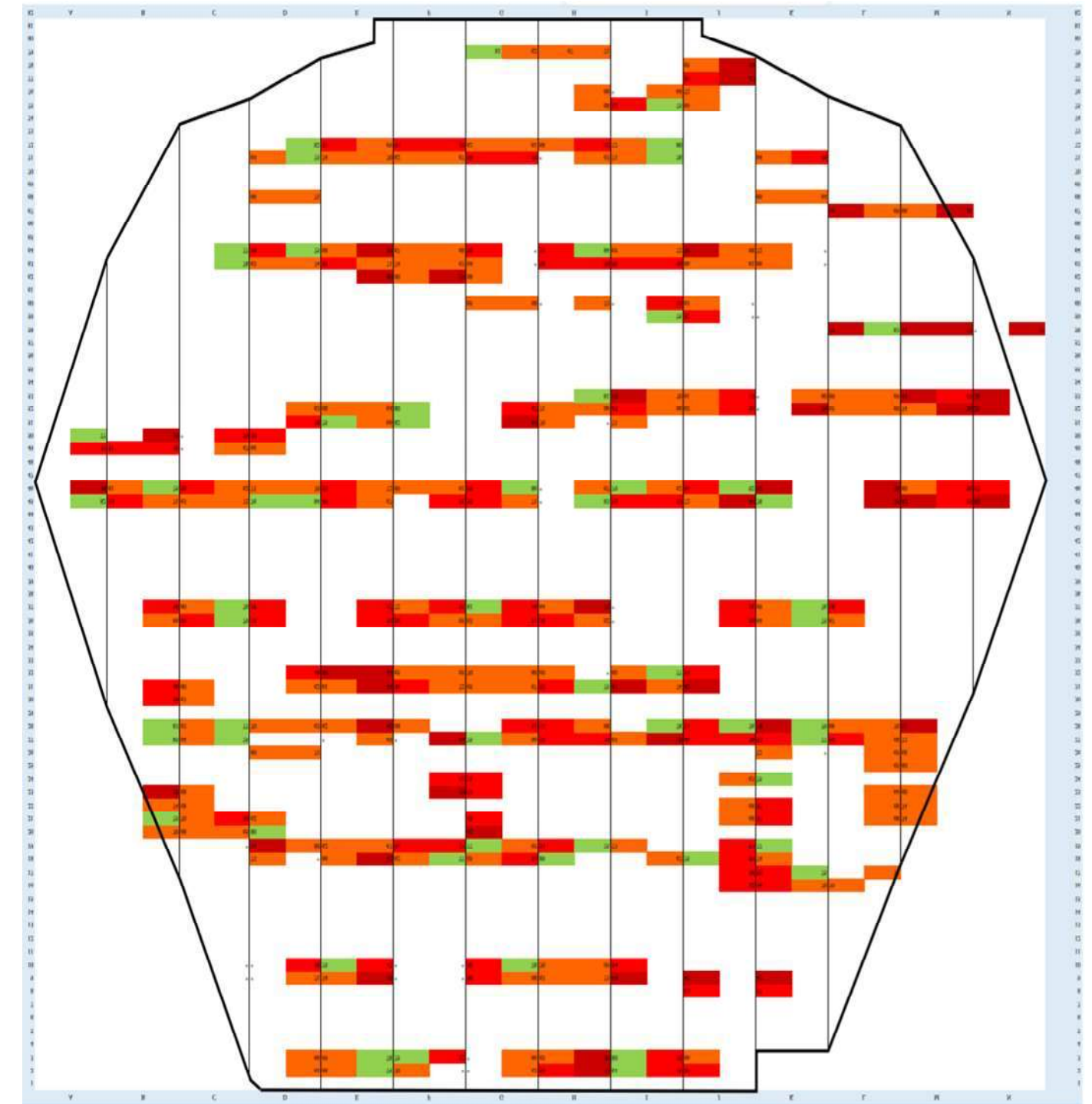

Figure 3-3 - End bearing length of RAAC roof panels













The findings of the intrusive investigations are summarised in the following table. Please note the following:

- Bearing lengths have been classified as per the colour coded system shown in Figure 3-3.
- Values for extent of transverse bar in bearing zone have been detailed red where no transverse reinforcement was found above the bearing length.

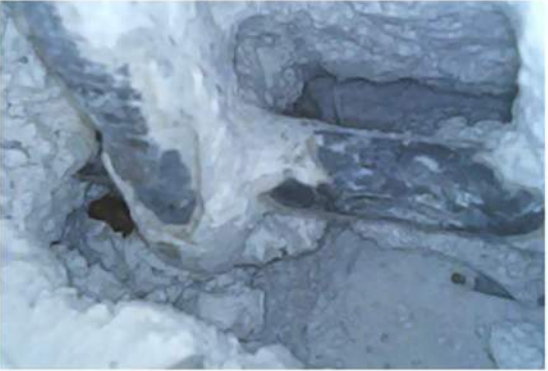
Table 3-1 - Summary of intrusive RAAC panel investigations

Location	Bearing on UB, RHS (mm)	Bearing on UB, LHS (mm)	Extent of transverse bar in bearing zone (mm)	Images
D26	71	60	60	 
K26	Measurement not obtained due to obstruction by debris or infill between adjacent planks.	72	52	 
H60	73	Measurement not obtained due to obstruction by debris or infill between adjacent planks.	68	 

<p>K71</p>	<p>46</p>	<p>64</p>	<p>52</p>	
<p>G60</p>	<p>68</p>	<p>65</p>	<p>20 (inset of bearing length).</p>	
<p>K68</p>	<p>64</p>	<p>66</p>	<p>56</p>	

D71	84	64	51	 
D68	71	66	55	 
H79	71	67	45	 
G79	62	81	47	 

4 SURVEY SUMMARY

'Poor bearing is a significant risk to the integrity of RAAC roof panels. The codes of practice associated with the design of RAAC from the 1950's to 1980's were CP114 Reinforced Concrete in Buildings and CP116 Structural Use of Precast Concrete.

These codes recommended minimum end bearings of only 45mm for roof panels and 60mm for floor panels. In practice, construction tolerances could have resulted in reduced bearing lengths.

To anchor longitudinal reinforcement, RAAC panels require transverse reinforcement over the bearing support. As noted by testing undertaken by the BRE (BRE IP 10/96), absence of transverse reinforcement at the end bearing can substantially impact on panel performance. The inspection of several buildings has identified that with short bearing lengths there is a risk that this critical anchorage reinforcement can be absent over the support face, presenting an increased risk of panel failure.

For this reason, a minimum as built bearing length 75mm is now considered to be necessary. Any bearing less than 75mm would be considered substandard and present an unacceptable risk to panels from shear failure or slippage and remedial actions are recommended.' RAAC Investigation & Assessment – Further Guidance, IStructE 2023.

Although visual inspection of the panels generally indicates good condition, some do exhibit properties which cause it to fall under the red and red (critical) risk categories as outlined by IStructE (**Figure 4-1**).

Red – End bearing checks undertaken by Rappel highlight a large majority of bearings <75mm, with the average bearing length found to be 62mm. Approximately 279 No. readings were found to be between 45mm ≤ X <75mm, which equates to 66% of readings taken.

Red (critical) – As identified on the intrusive surveys, 1 out of the 10 survey points were found to lack required transverse reinforcement, equating to 10%. Extrapolating this value, we would therefore anticipate 93 No. panels to not have a transverse bar over the support over the entirety of the site.

Red (critical) – 49 No. end bearing measurements were found to be <45mm, which equates to 12% of readings taken. Due to these being below the original design criteria (45mm), they are to be classified as red (critical).

Figure 4-1 – Support/bearing condition risk categories (RAAC Investigation & Assessment - Further Guidance, IStructE 2023)

Support / bearing condition	Risk category
Bearing investigated and found to lack required transverse reinforcement	Red (critical)
Cut or modified panels, including where cut panels are supported on proprietary hangers	Red (critical)
Bearing <75mm with transverse anchorage reinforcement	Red
>75mm with transverse anchorage reinforcement	Green

LIMITATIONS

Please note that only a proportion of all RAAC panels at St Davids Hall have been examined.

5 REMEDIAL OPTIONS

A potential remedial action could be proposed to improve the end bearing condition of the RAAC panel such as supplementary steel support bracketry.

5.1 SUPPLEMENTARY STEEL SUPPORT BRACKETRY

A potential remedial action would be the introduction of steel angles bolted to the existing steel UB purlins (Figure 5-1). Angles of CIRCA 1.8m long would support the end of 3 RAAC panels providing an enhanced end bearing, mitigating any risks associated with known deficiencies/unproven end bearing conditions. Installation of the supplementary bracketry would require the drilling of the existing UB's to receive the new bolts.

Please note, this remedial solution would require further detailed structural design should Cardiff City Council wish to proceed.

Figure 5-1 - Remedial solution - supplementary steel support bracketry solution

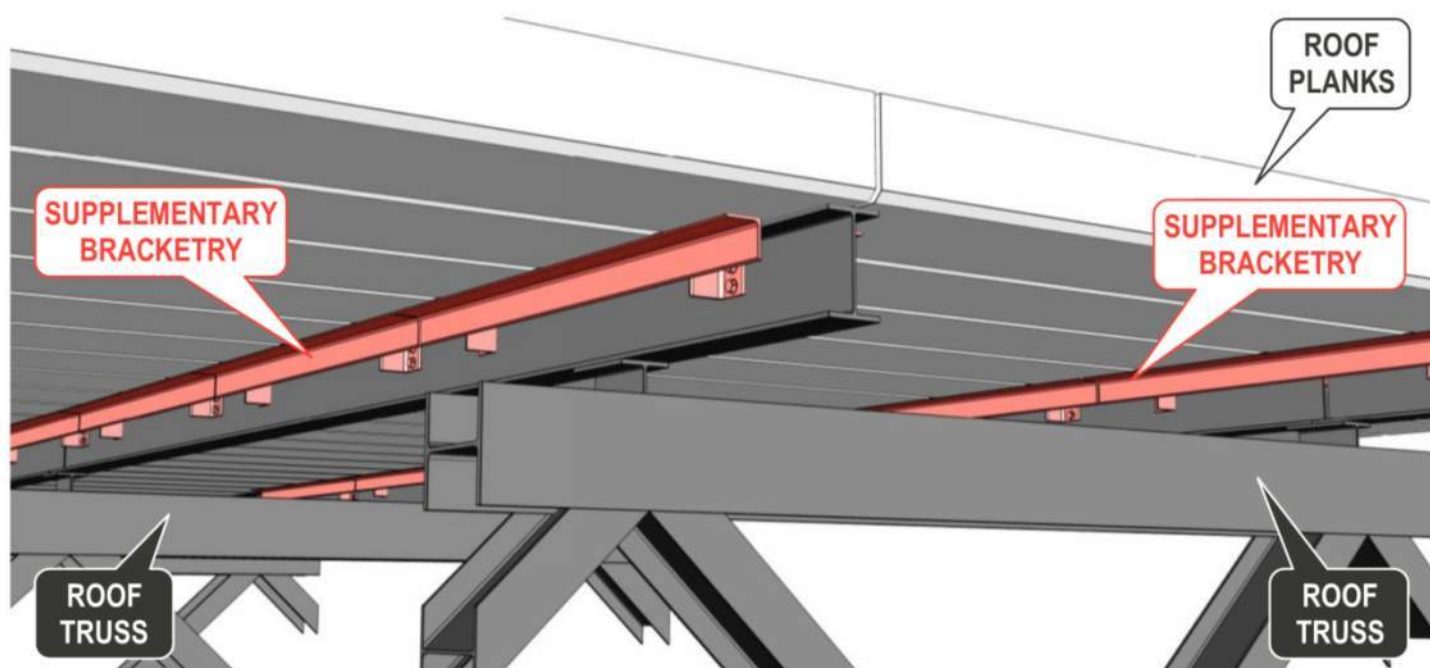

6 CONCLUSION

According to all investigative results collected and further engineering judgement, St David's Hall will fall under the **Red – Critical Risk category**.

The IStructE Guidance therefore requires, as presented in the table extract below that urgent remedial works are required. This may include taking out of use or temporary propping allow safe ongoing use of the building.

This report has identified the urgent temporary remedial works that would be necessary. These would entail significant access to the roof areas either through roped access or scaffolding. Given that these works would be considerable, and there remains a risk of further deterioration of the panels, replacement of the RAAC panels should be given consideration.

In considering replacement structures, consideration needs to be given to the self-weight / dead loading of the replaced element and the acoustic performance of the theatre space in terms of mass and surface hardness.

The duty holder of the building should next undertake a risk assessment of the building considering the risks identified in this report, the use of the building and the published guidance from the HSE.

Figure 6-1 – RAAC Assessment category and associated risk types (RAAC Investigation & Assessment - Further Guidance, IStructE 2023)

Assessment category	Risk category	
Red	Critical risk	Requires urgent remedial works which may include taking out of use or temporary propping to allow the safe ongoing use of a building. Depending on the extent, this may be part or all of the building. Combined with awareness campaign for occupants including exclusion zones.
	High risk	Requires remedial action as soon as possible. Combined with awareness campaign for occupants, which may include exclusion zones, signage, loading restrictions and the need to report changes of condition, eg, water leaks, debris, change in loading, etc.
Amber	Medium risk	Requires inspection and assessment on a regular basis, eg, annually. Combined with awareness campaign for occupants, which may include signage, loading restrictions and the need to report changes of condition, eg, water leaks, debris, etc.
Green	Low risk	Requires inspection and assessment occasionally, say three year period depending on condition. Combined with awareness campaign for occupants, which may include signage, loading restrictions and the need to report changes of condition, eg, water leaks, debris, etc.

Appendix A

RAPPEL SURVEY DATA - END BEARING MEASUREMENTS



Location: E 63+64, D 63+64, E 63+64

Location: F 63+64, G 63+64, H 63+64

64

64

77 \leftrightarrow 56 75 \leftrightarrow 68 39 67 68 \leftrightarrow 50 * \leftrightarrow 53 84

63

63

78 \leftrightarrow 63 74 \leftrightarrow 55 71 74 63 \leftrightarrow 64 * \leftrightarrow 58 58

148

147

148

148

148

149

Page 56

Location: I 63+64, J 63+64, K 63+64

Location:

64

65 72 \leftrightarrow 38 68 \leftrightarrow 72 *

63

50 56 \leftrightarrow 66 61 \leftrightarrow 66 *

149

148

148

\leftrightarrow

* \leftrightarrow

\leftrightarrow

* \leftrightarrow

\leftrightarrow

* \leftrightarrow

Location: F 45/46

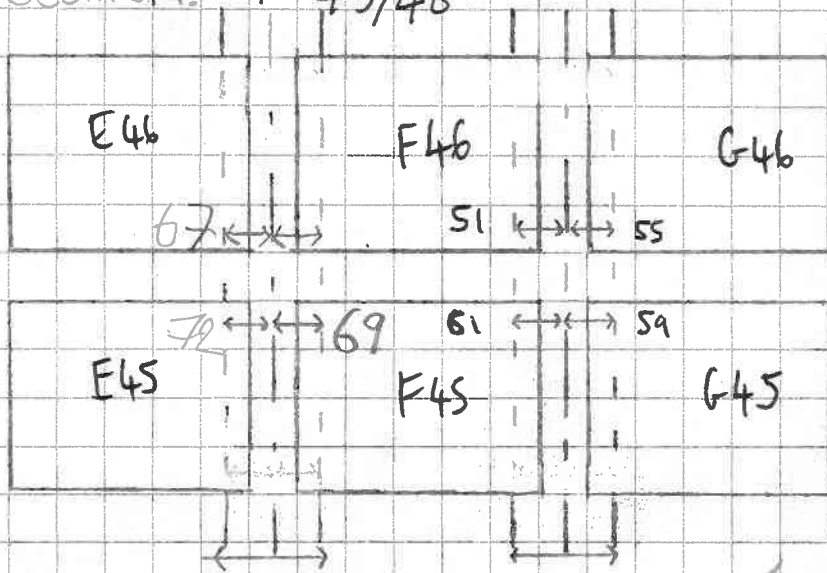

Location:

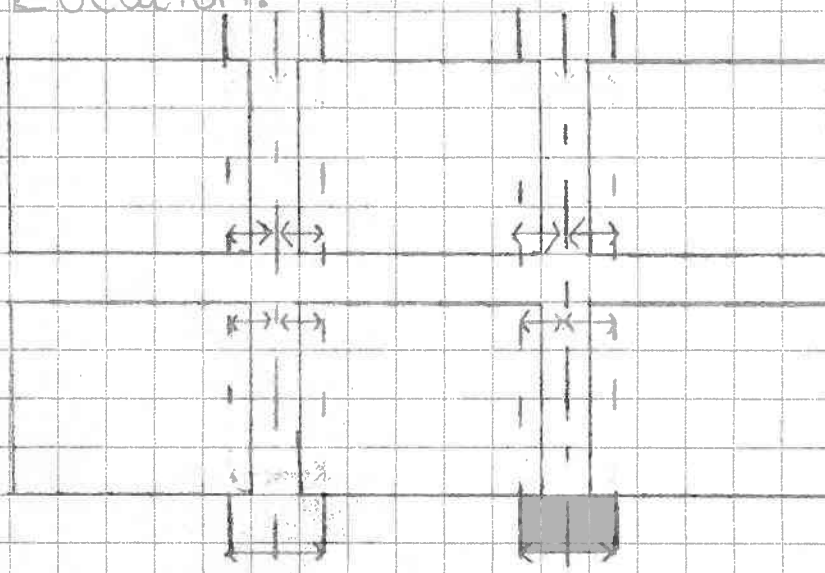

TJ
27/9

Location:

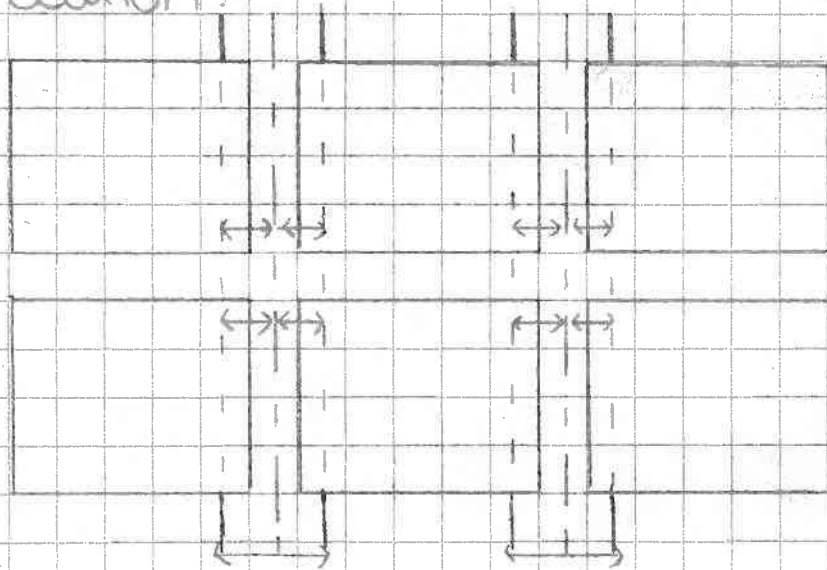

Location:

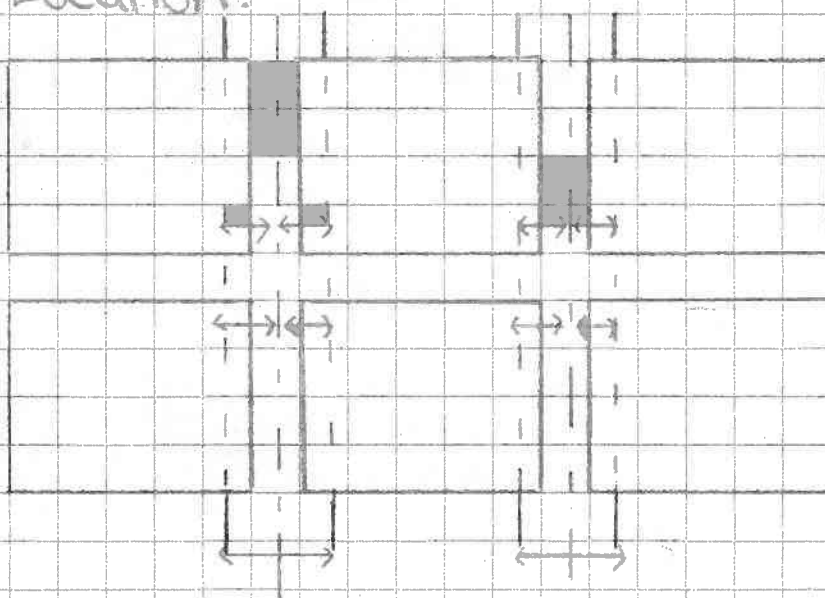

Location: F36

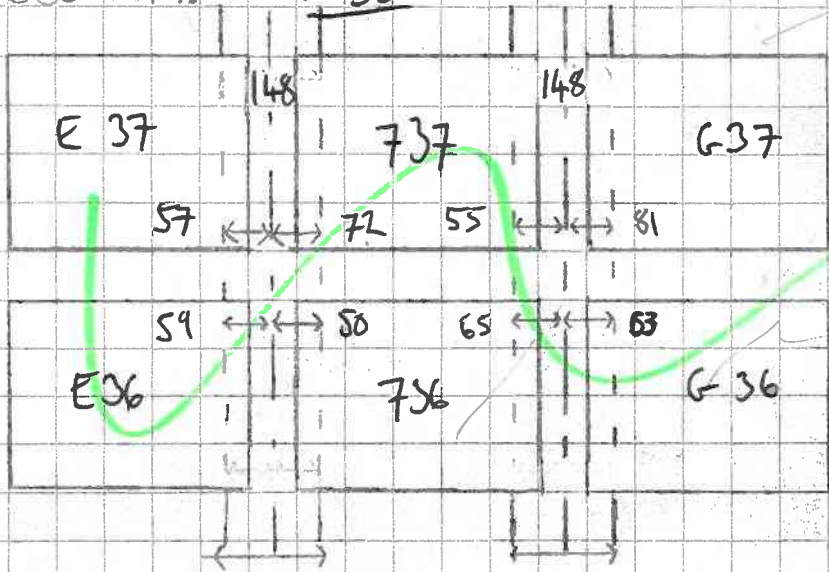

Location: H36

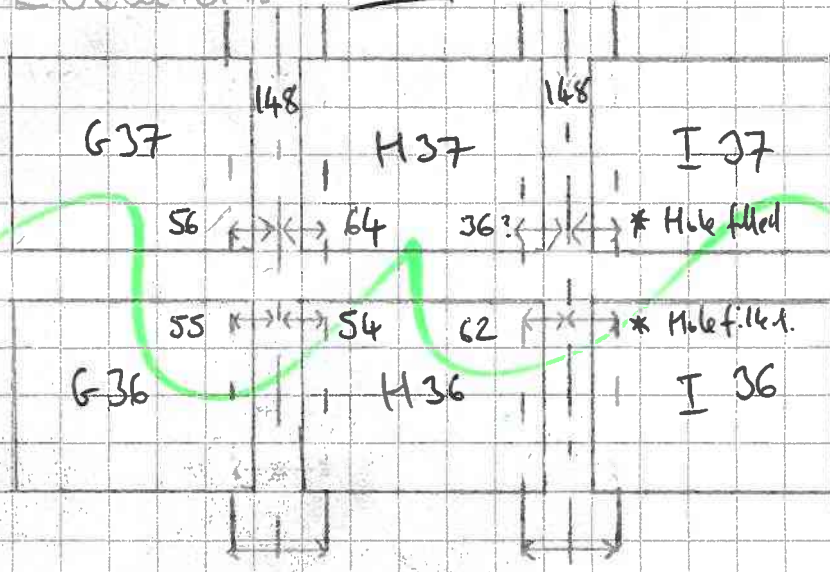

TJ
27/9

Page 58

Location: B46

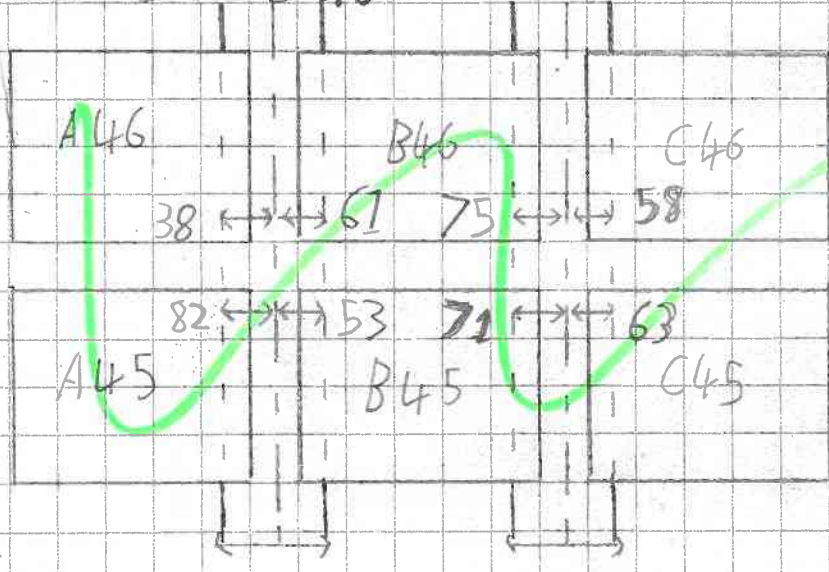

Location: D46

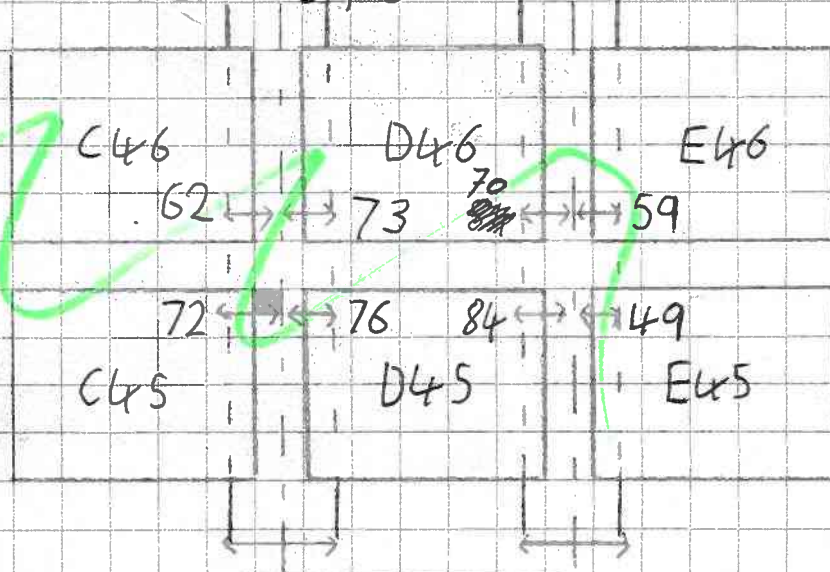

Location: D18

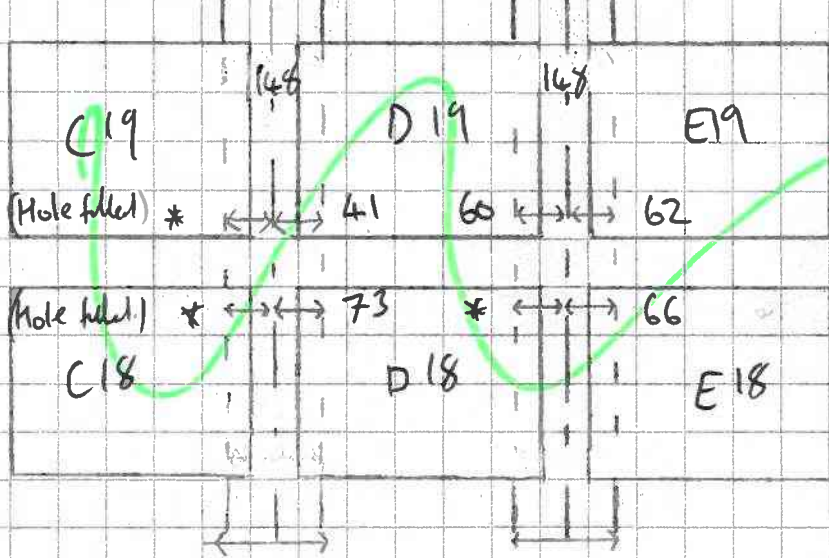

Location: F18

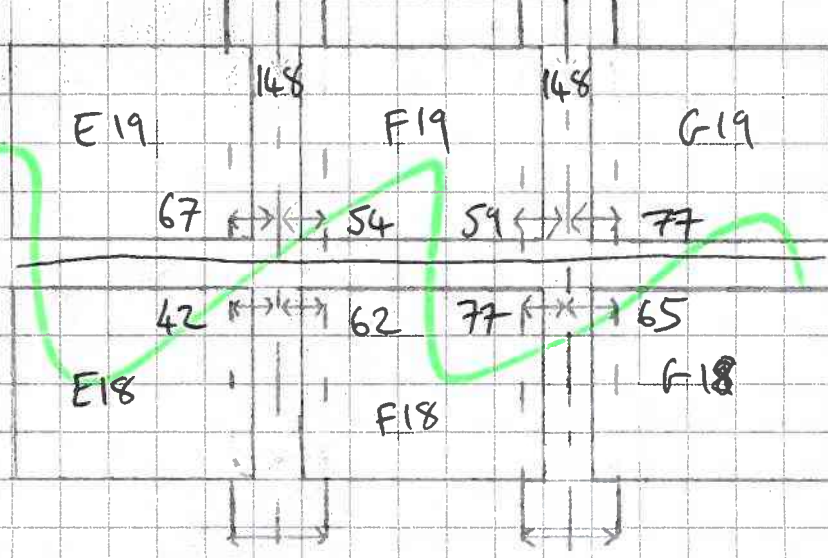

TJ
26/9

Page 59

Location: C27

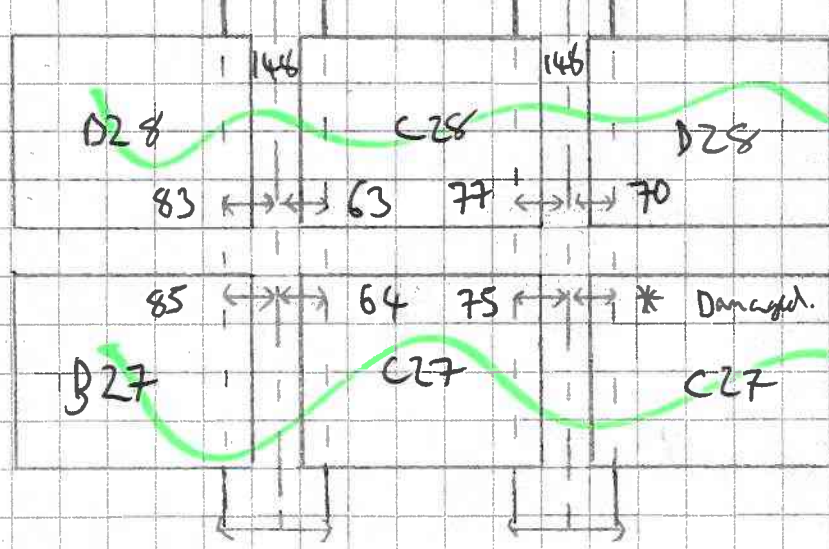

Location: E27

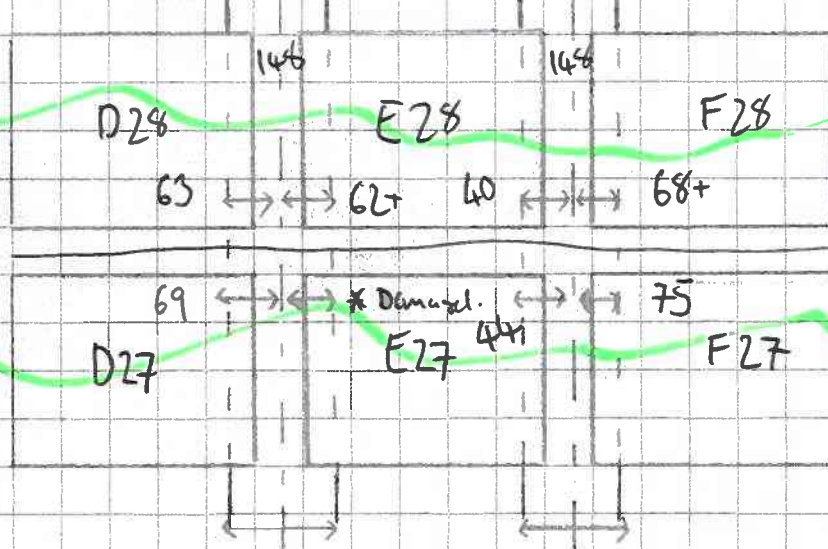

Location: E 31

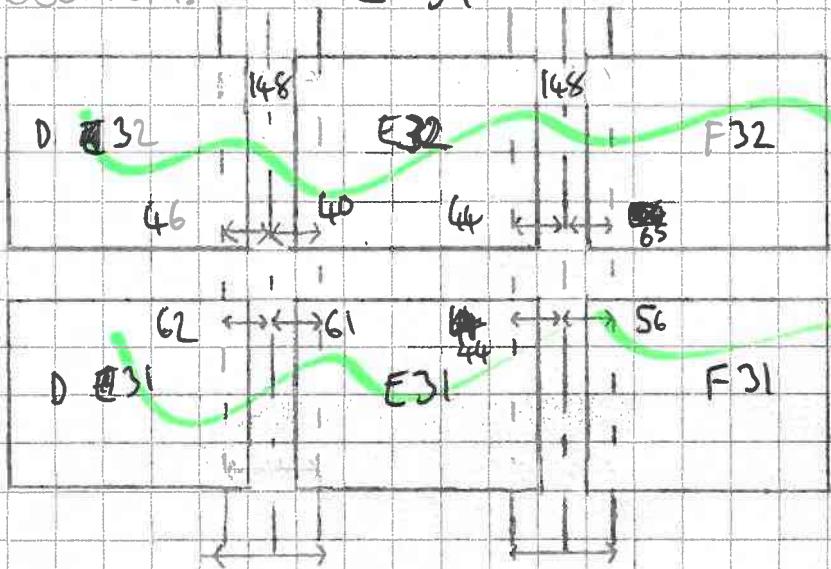

Location: G 31

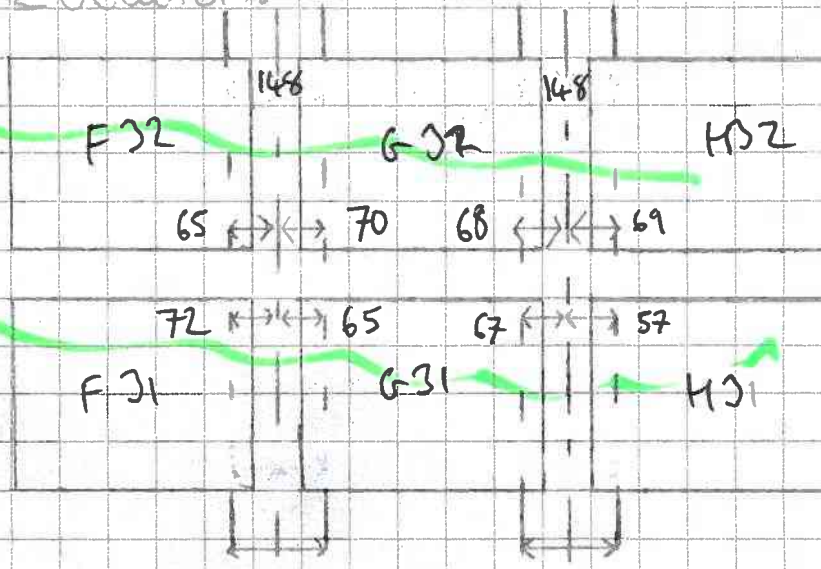

TJ
26/9

Page 60

Location: I 31

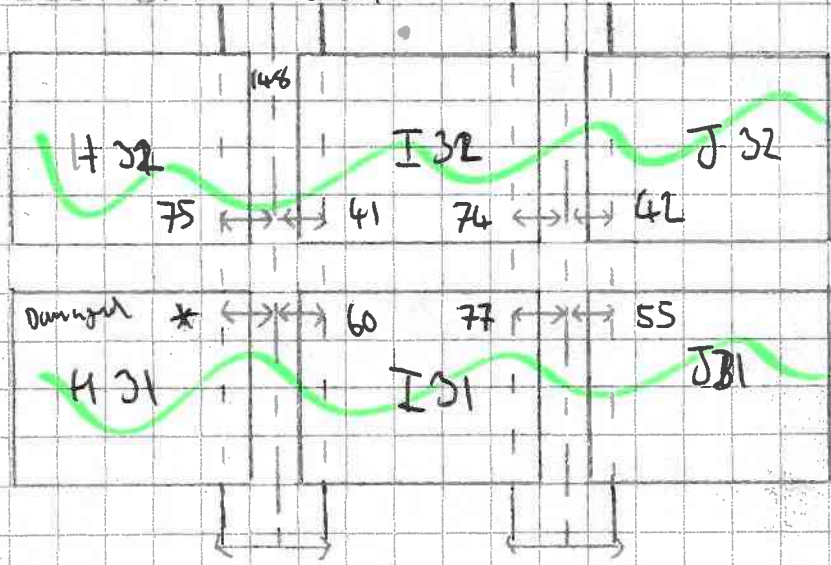

Location:

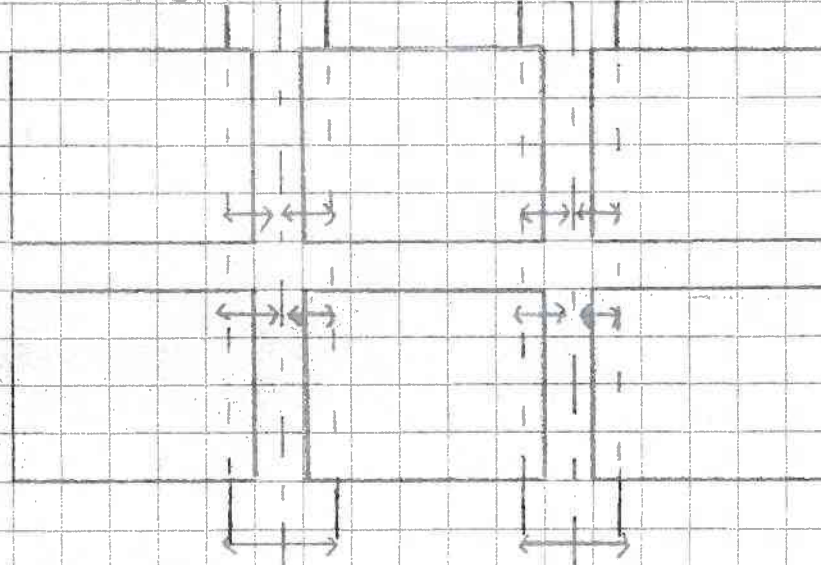

Location: K36

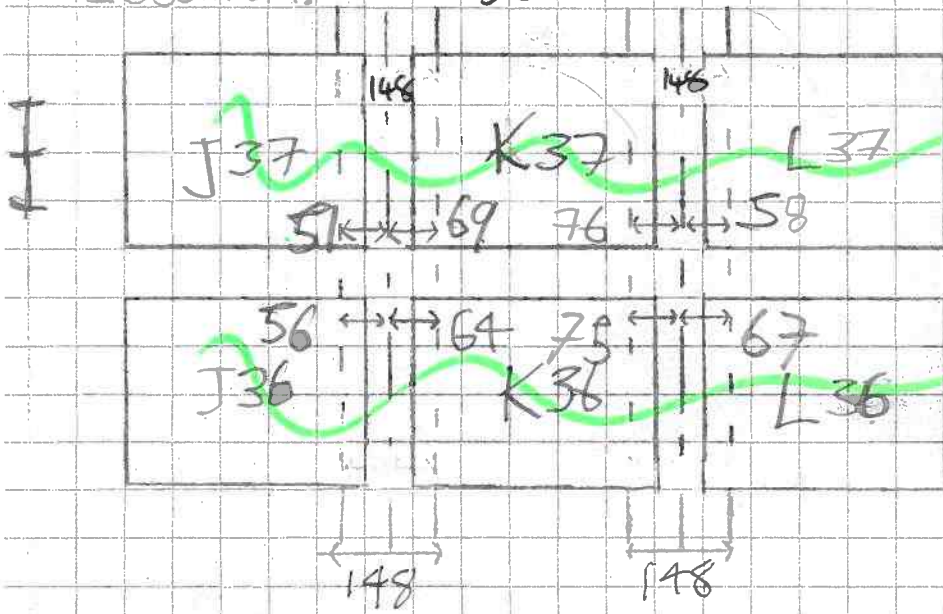

Location: C36

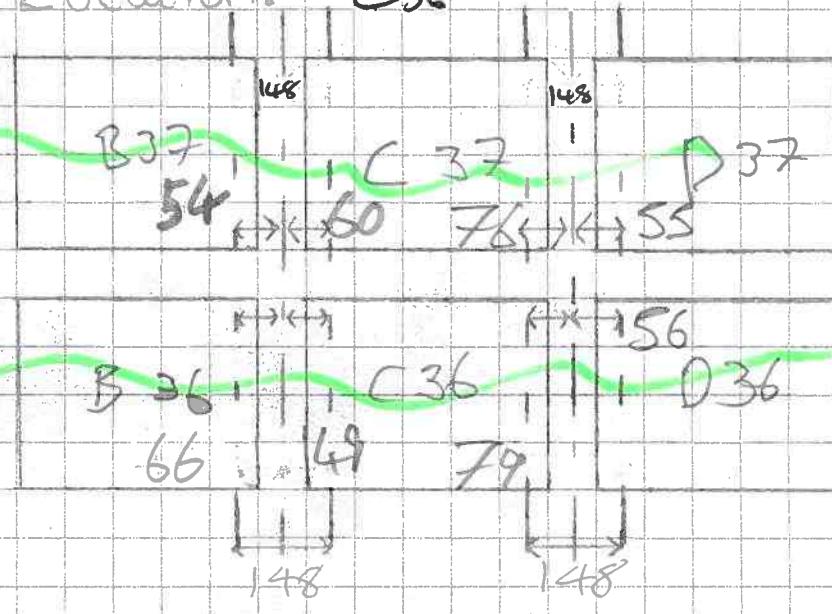

Page 61

Location:

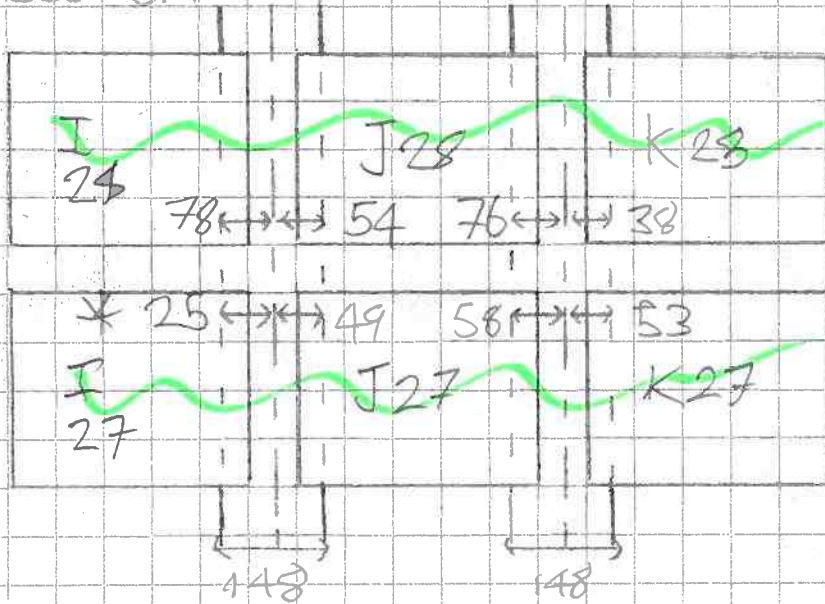

Location:

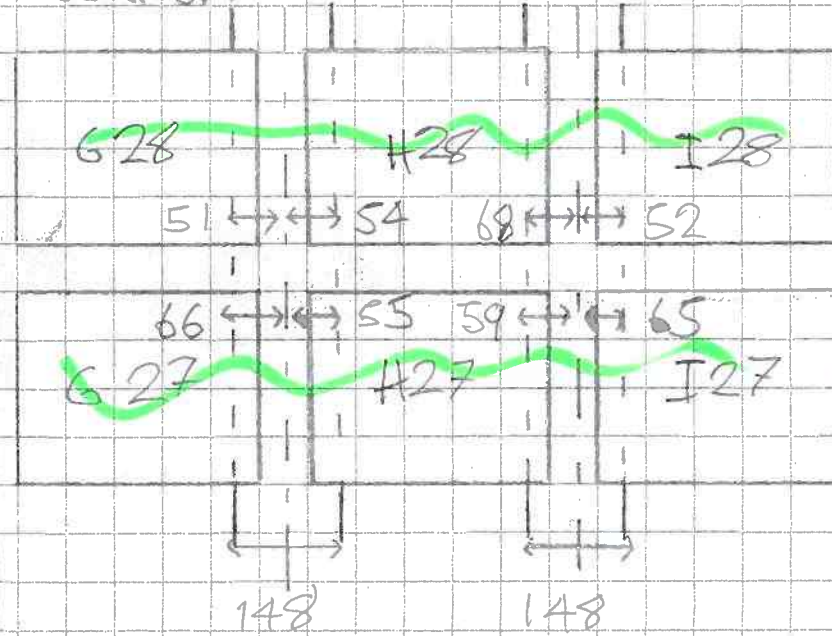

Location: J18

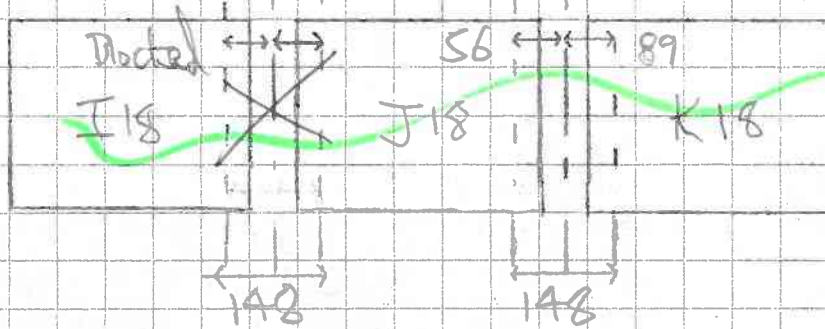
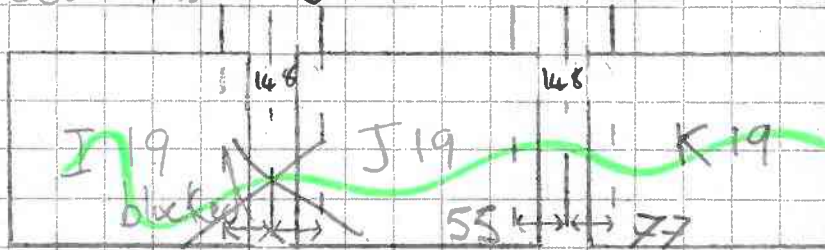

Location: H18

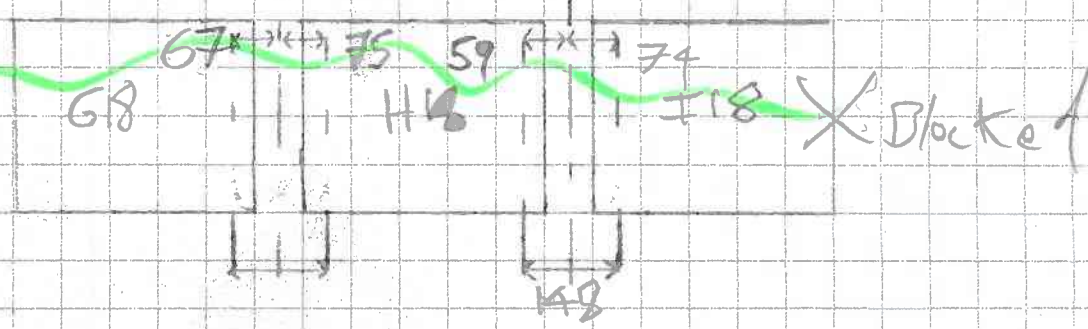
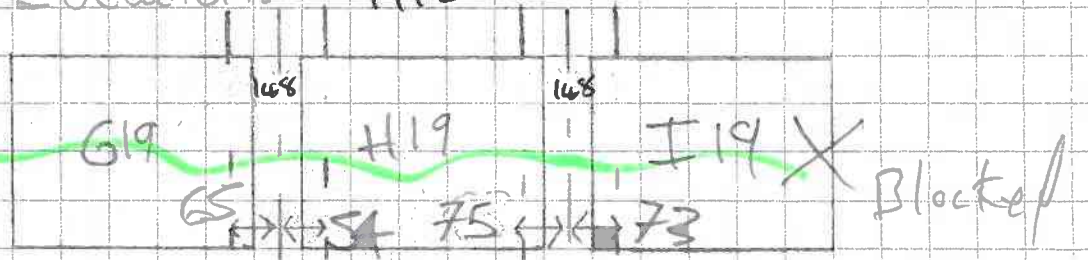

Page 62

Location: L27

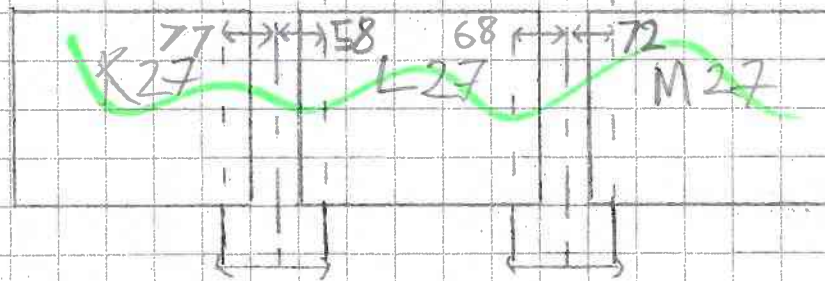
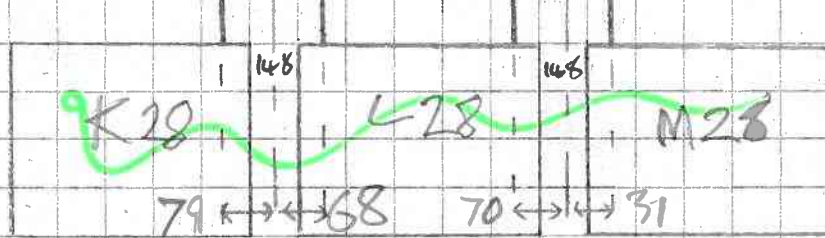

Location: J27

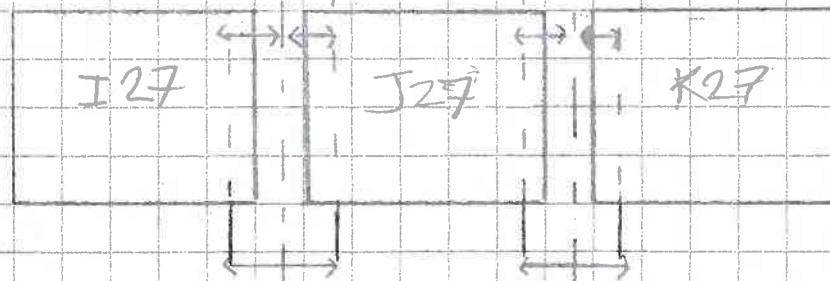
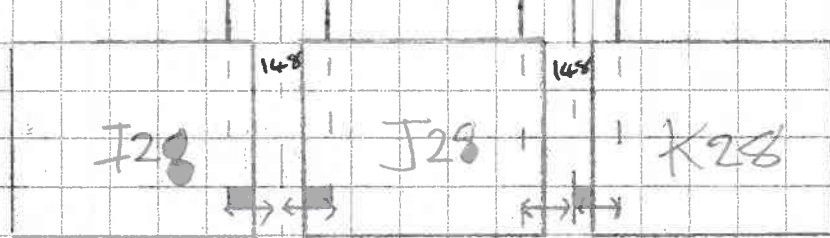

Location: 148

148

148

Location: 148

148

148

148

H53

I53

J53

K53

L53

M53

N53

81

40

70

61

59

*

60

69

69

44

49

26

H52

I52

J52

K52

L52

M52

N52

81

40

66

63

56

*

39

65

6

64

36

25

* OBSTRUCTED

Location:

Location:

K53

K52

Location:

★ABSTRACTED Location:

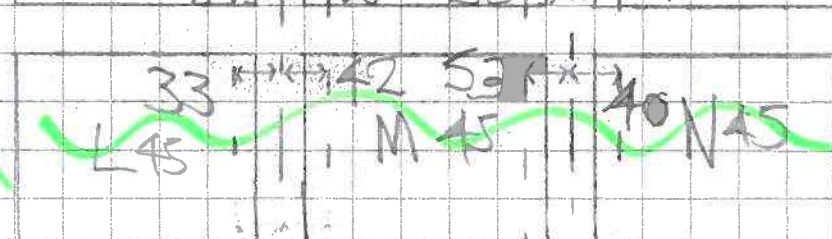
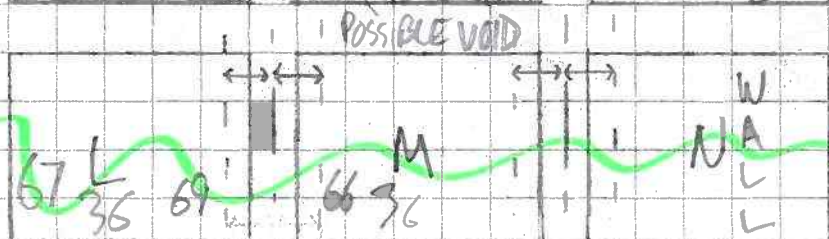
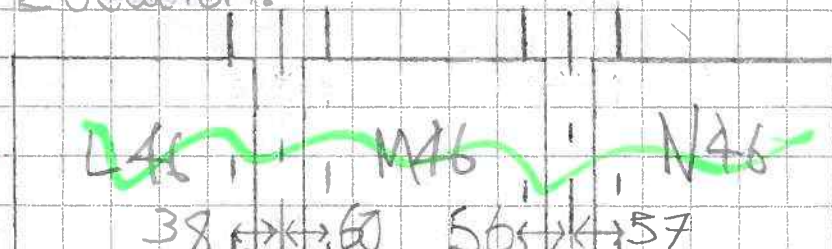
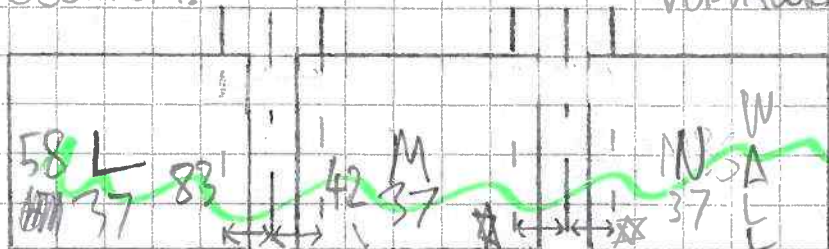

Page 64

Location:

Location:

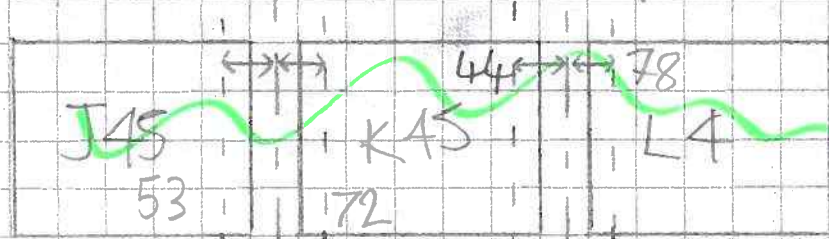
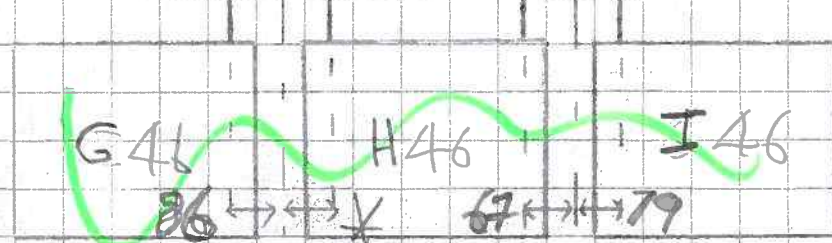
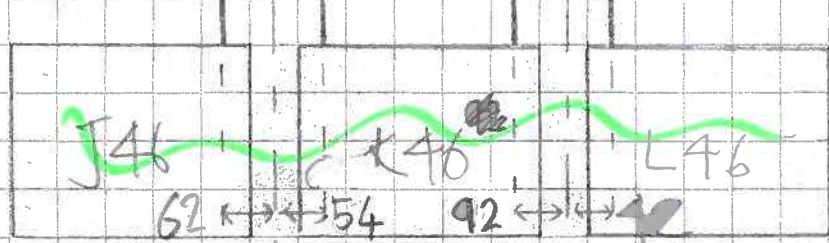

M37 - APPEARS TO CONTINUE FURTHER INTO THE WALL LONGER SLAB

Location:



Location:

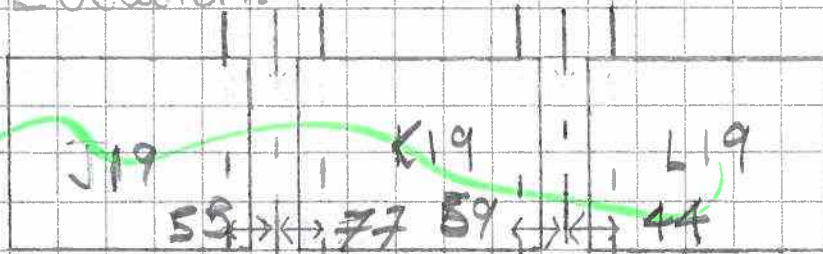

AB

7519

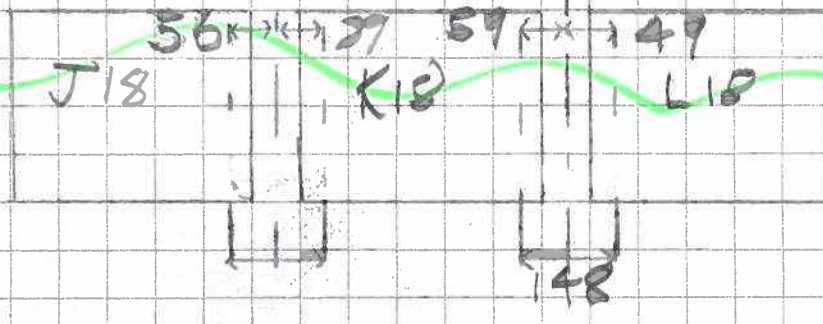
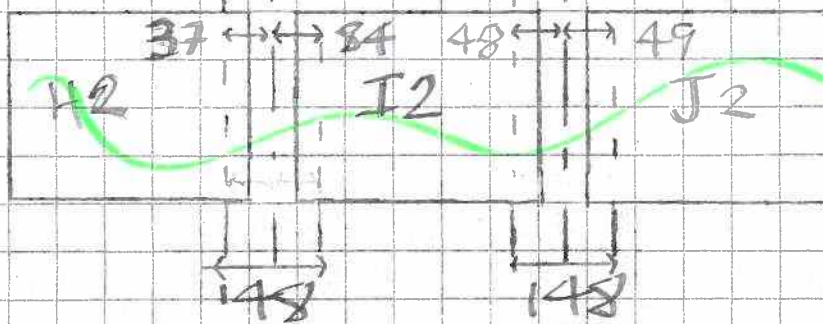

Page 65

Location:

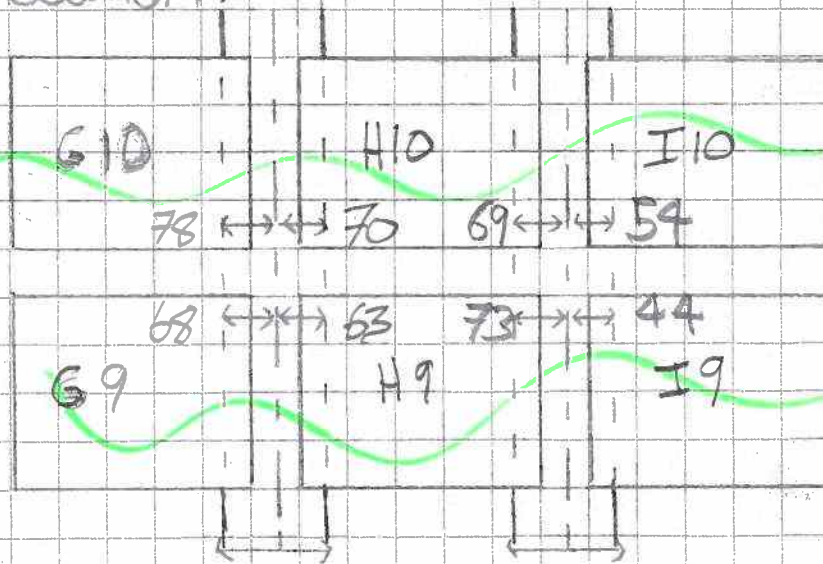

Location:

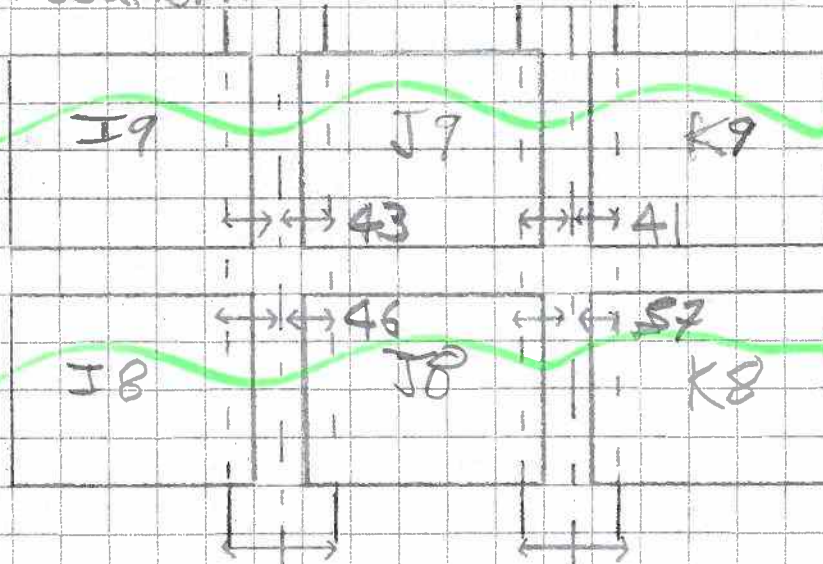

Location: E 02

Location: G 02

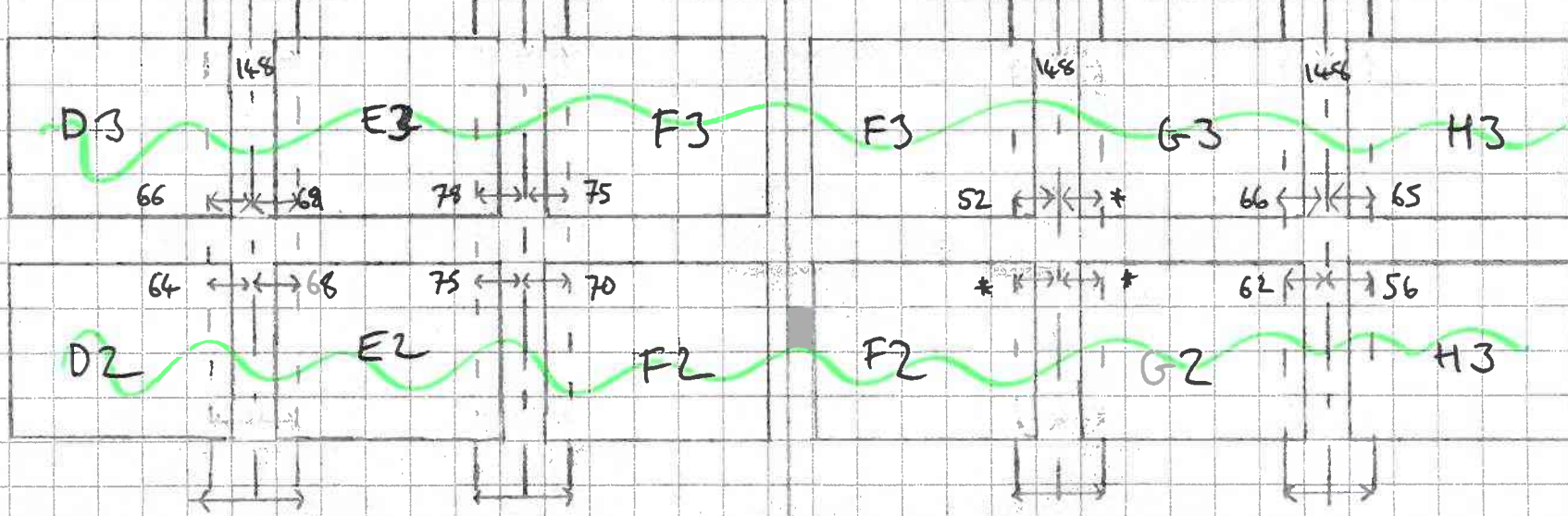

TJ
25/9

Page 66

Location: D 09

Location: F 09

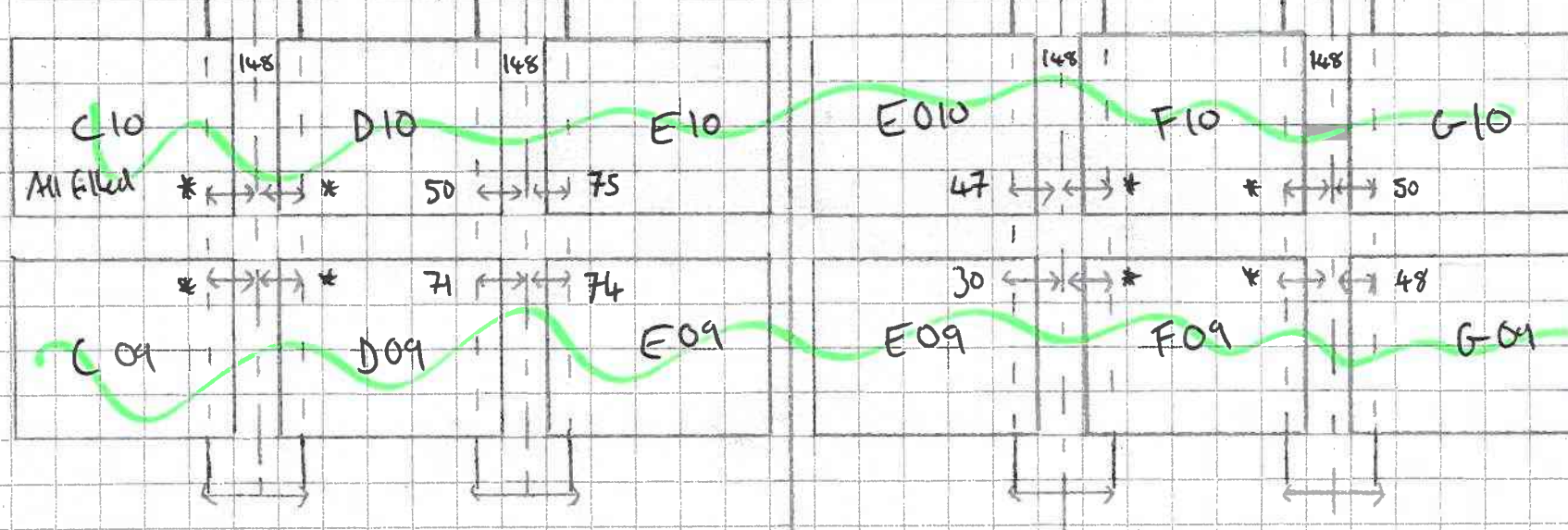

Location: C 49

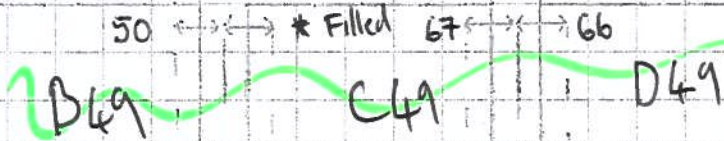
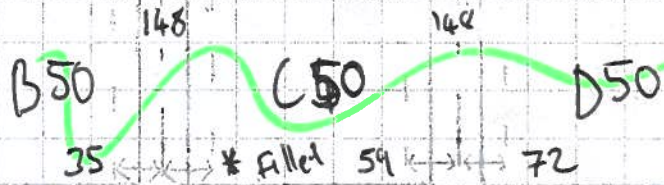

Location:

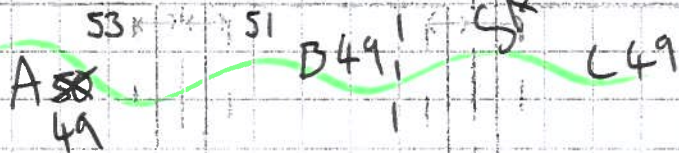
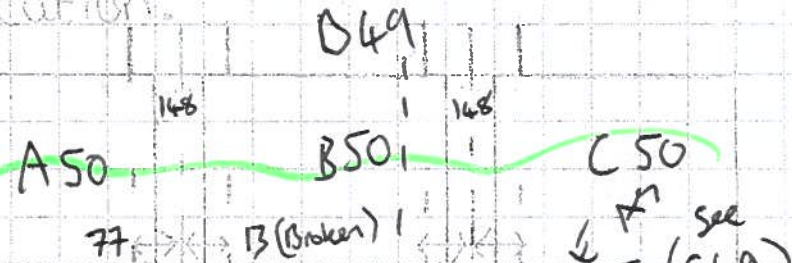

* 1
TEAM
TJ
28/9

Page 67

Location: D 51/52

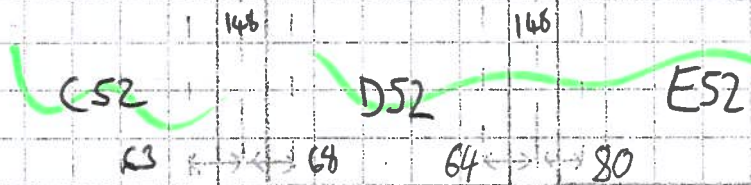

Location: G 51/52

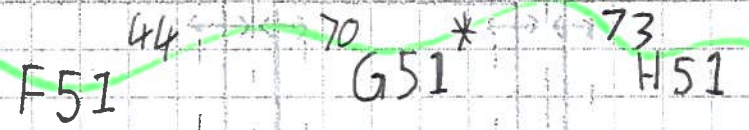
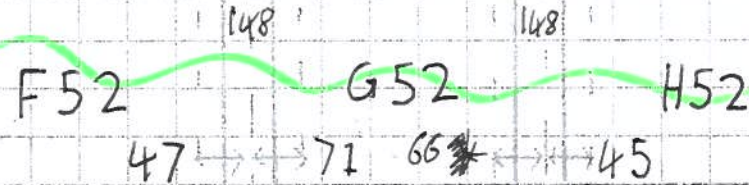

Location: E59

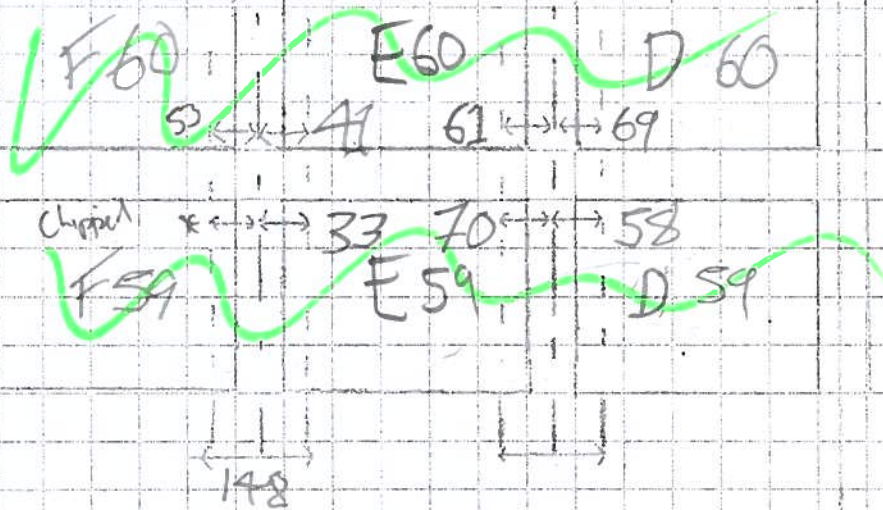

Location:

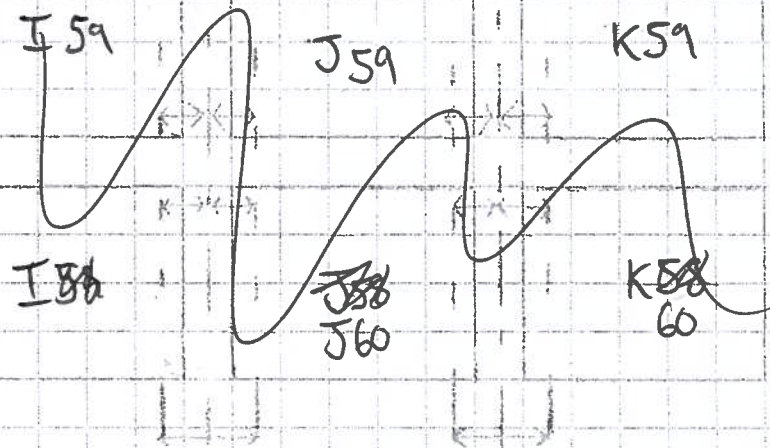

TEAM T5

28/9

Page 68

Location: J59

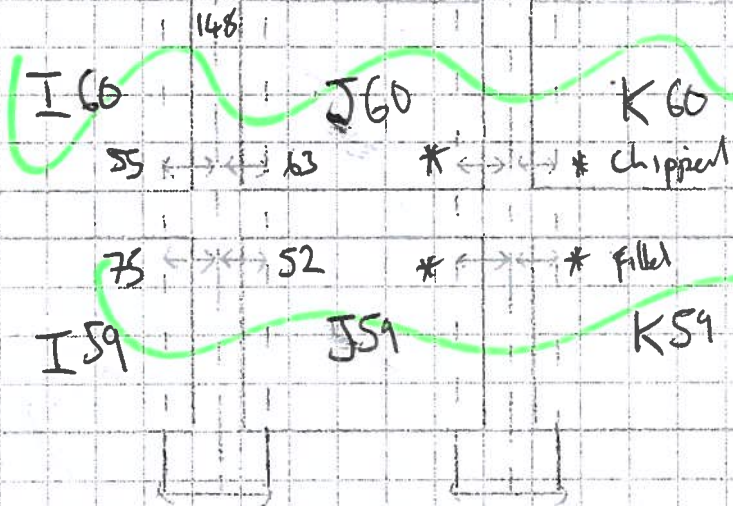

Location: F63

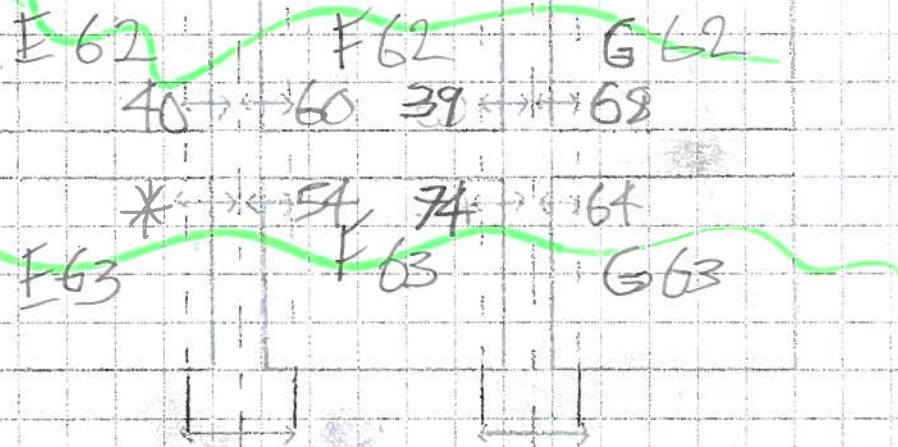

Location: D 71+72, E 71+72, F 71+72 | Location: G 71+72, H 71+72, I 71+72

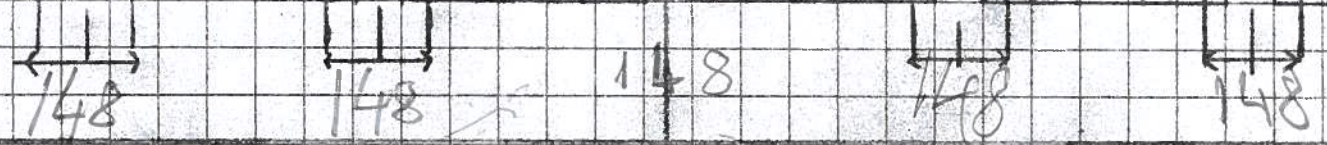
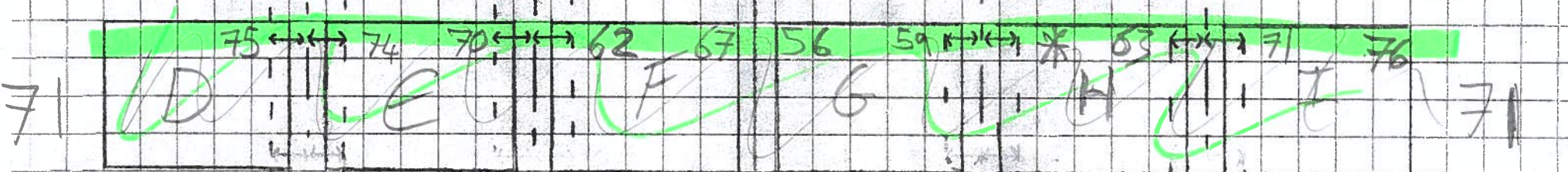
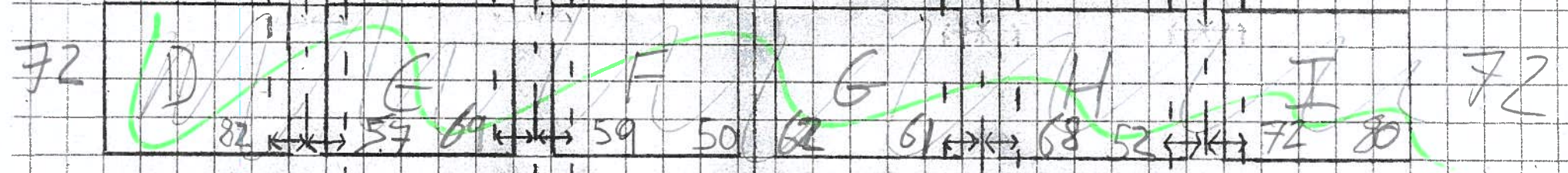

Page 69

Location: E 77+78, F 77+78, G 77+78 | Location: J 71+72

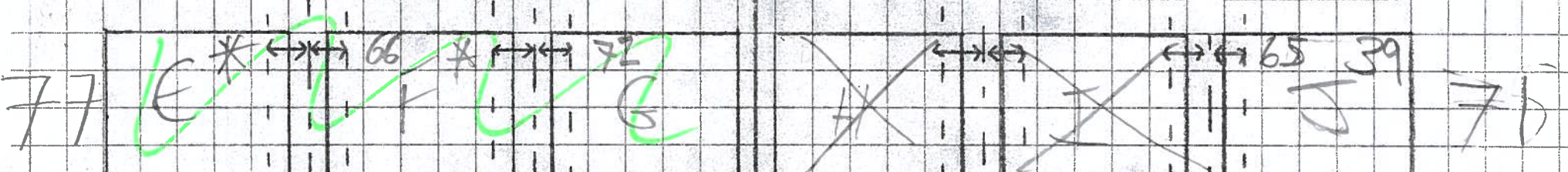
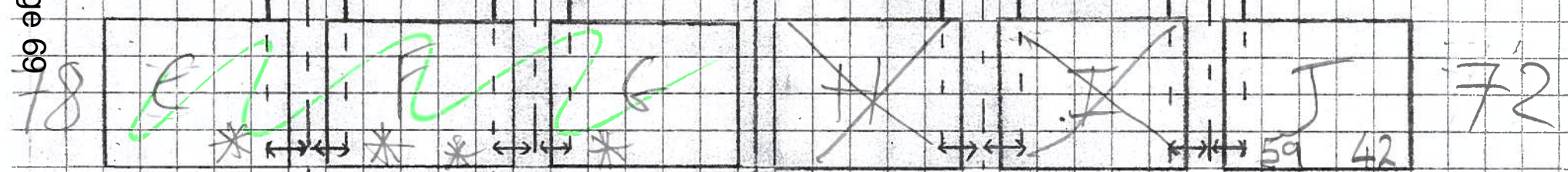

Location: H 75+76, I 75+76, J 75+76 Location:

76

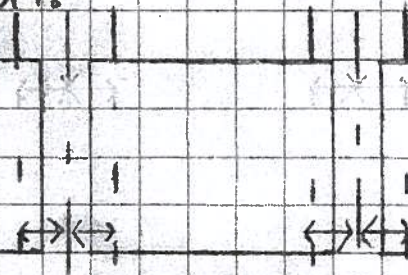
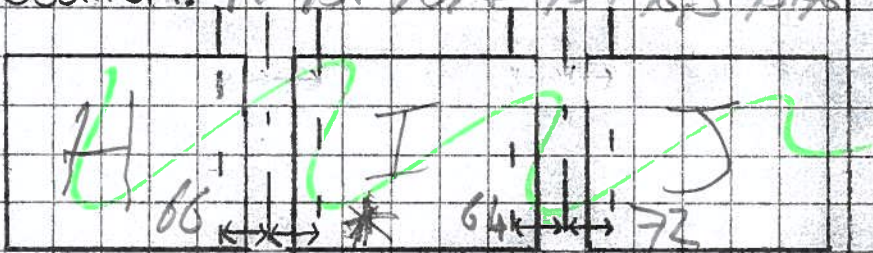

75

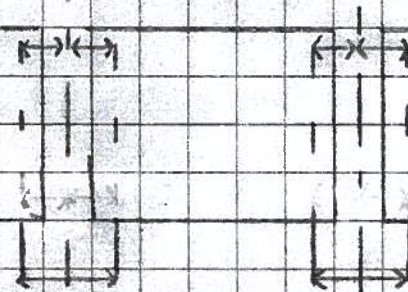
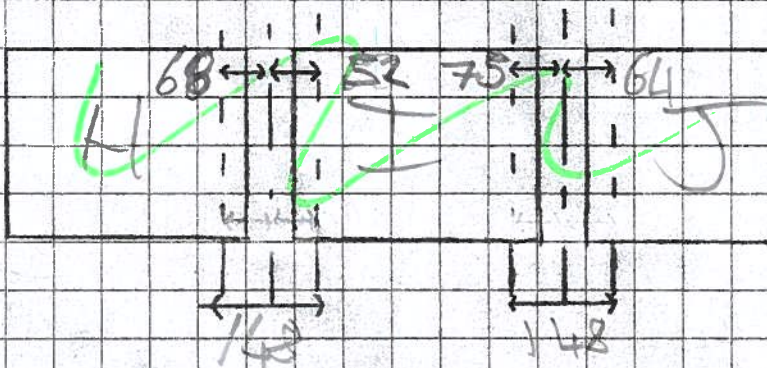

Page 70

Location:

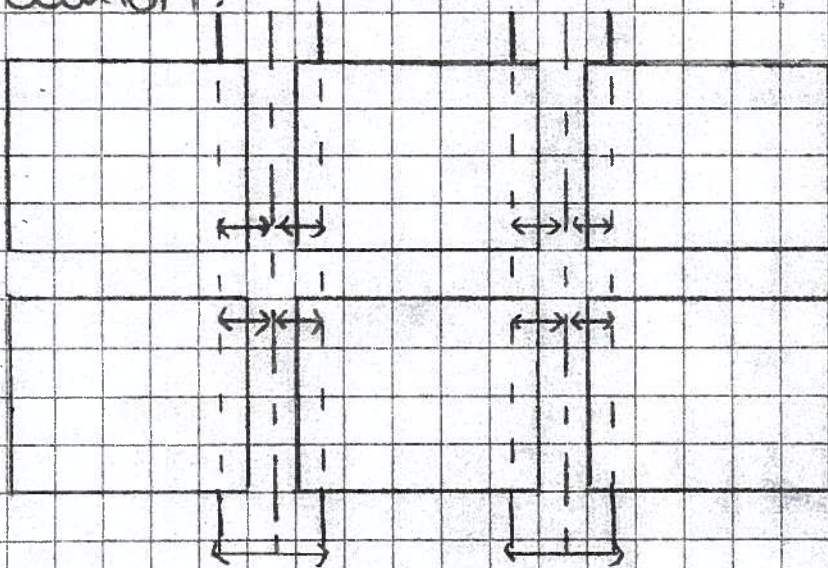

Location:

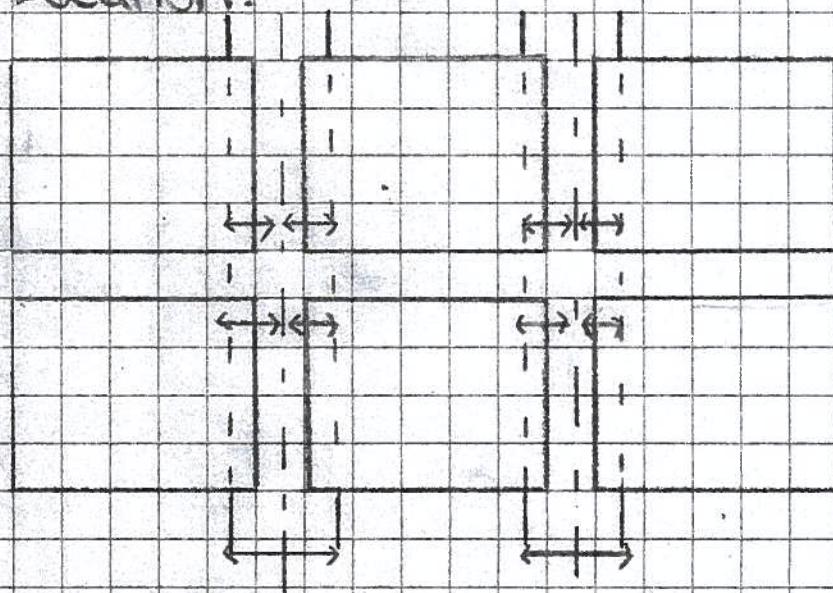

Location: $\angle Z_3 + Z_4, M Z_3 + Z_4$

Z4

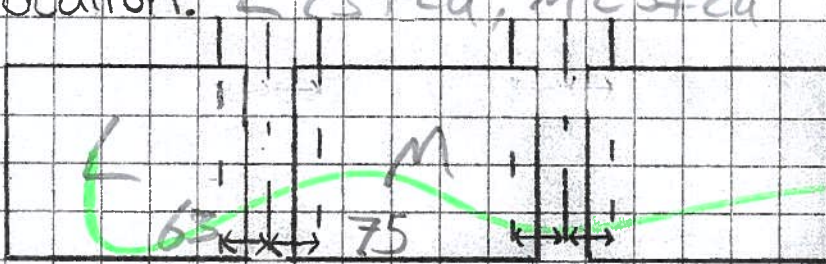

Location: $\angle Z_5 + Z_6, M Z_5 + Z_6$

Z6

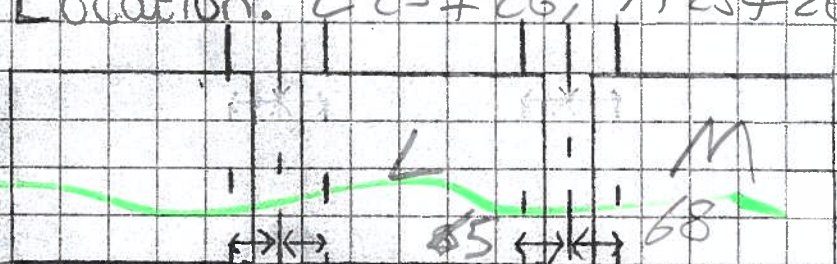

Z3

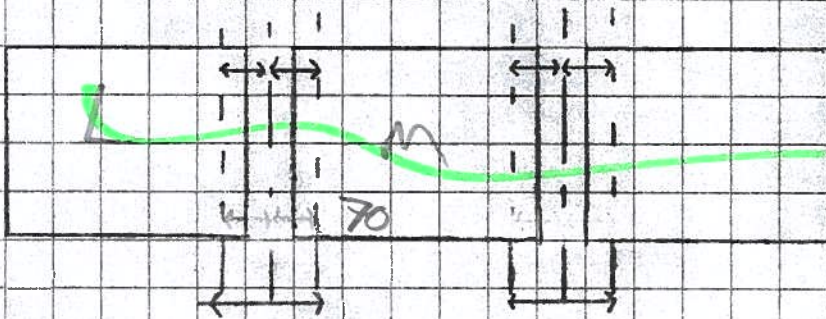

Z5

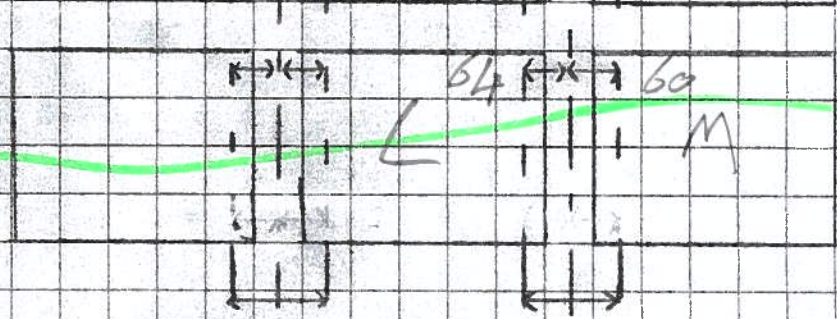

Page 71

Location: $\angle S/6 + 17, K/6 + 17$

17

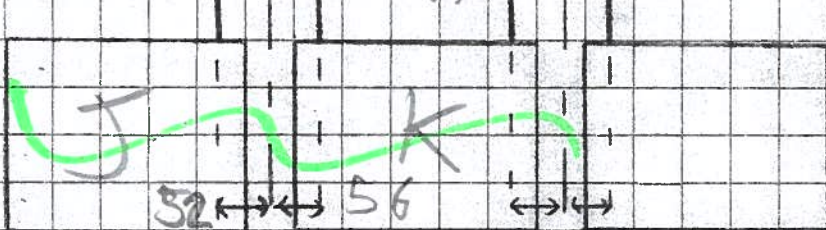

Location:

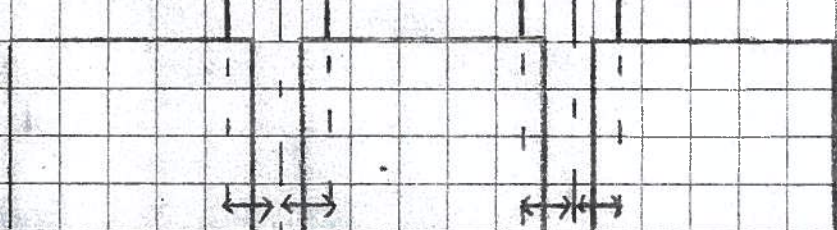

16

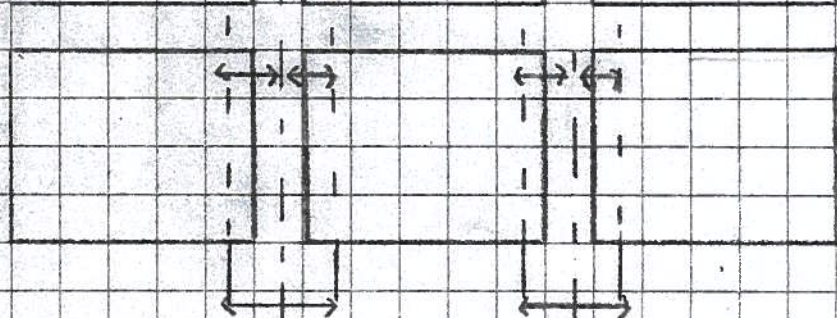
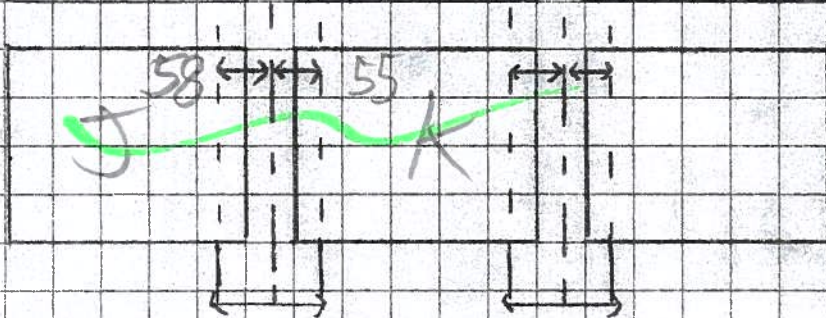

Location: K 17+16, L 17+16

Location: K 15

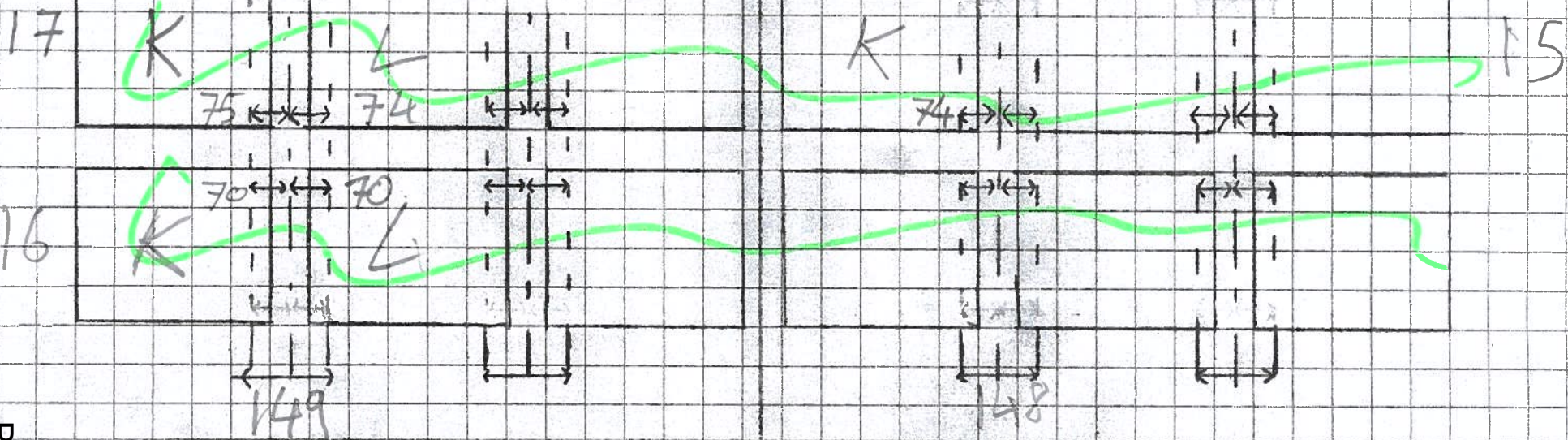

Page 72

Location: J 21+22, K 21+22

Location: L 20+21, M 20+21

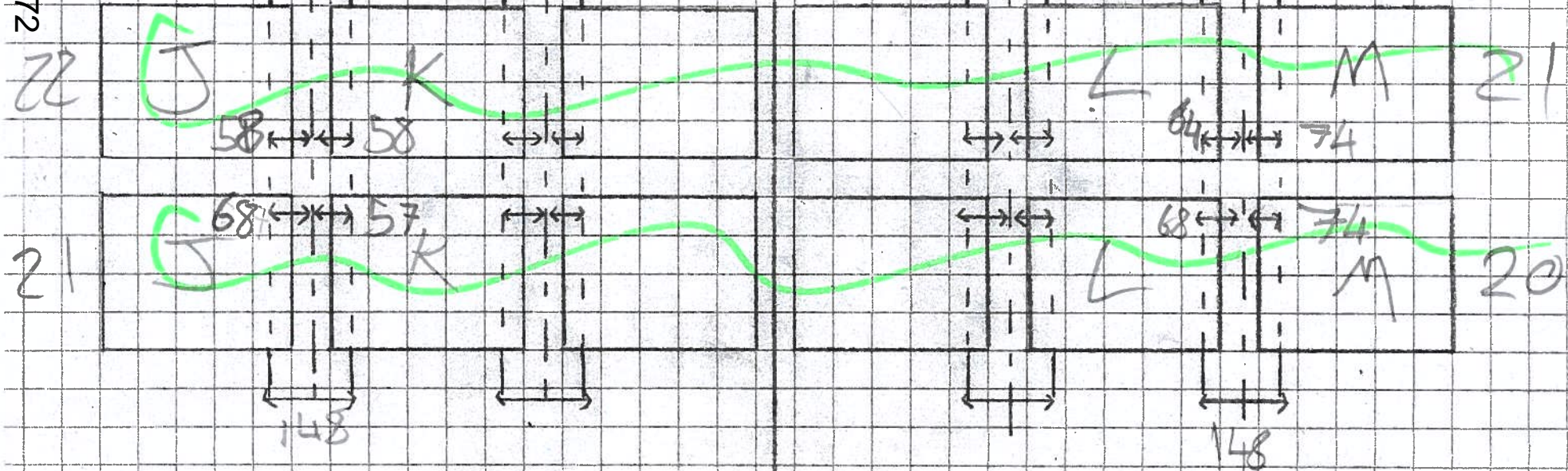

Location: C 20+21, D 20+21

Location: B 22+23, C 22+23

21

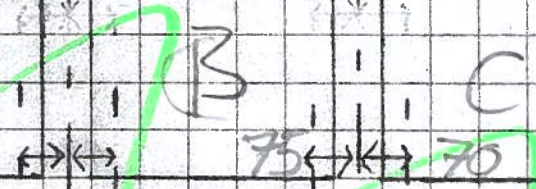
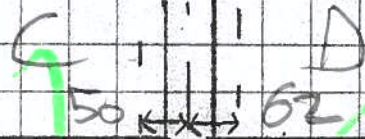

23

20

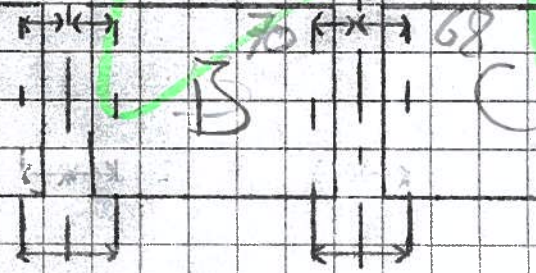
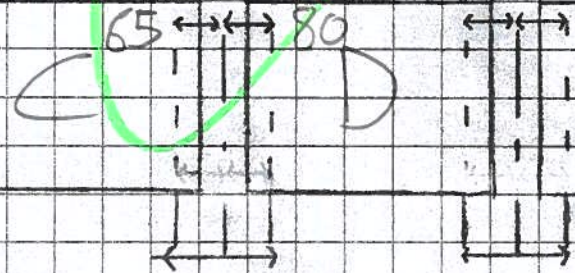

22

Page 73

Location: F 23+24, G 23+24

Location: B 25+26, C 25+26

24

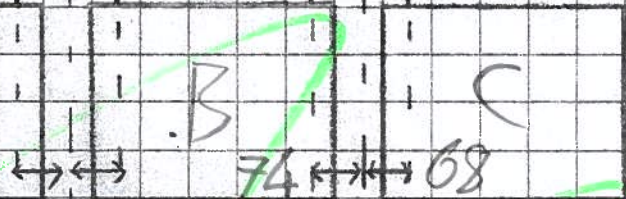
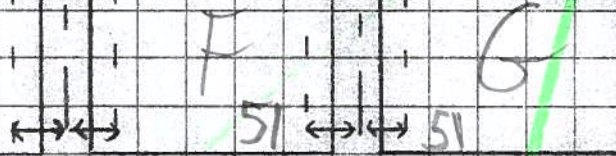

26

23

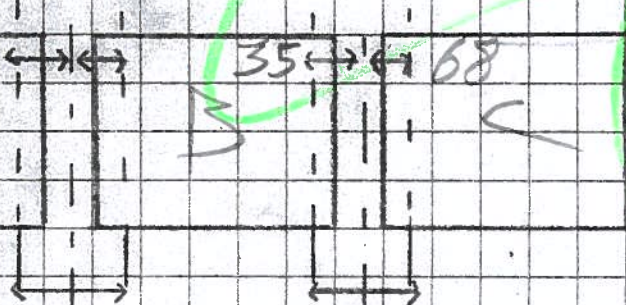
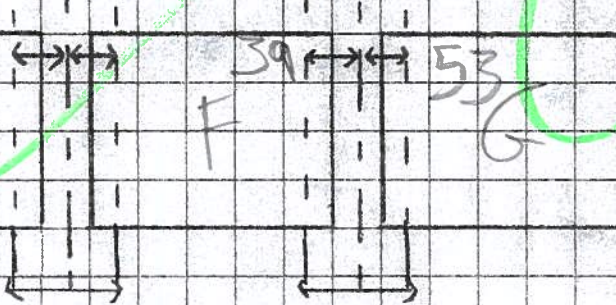

25

Location: B30+31, C30+31,

Location: B32+33, C32+33

Z1

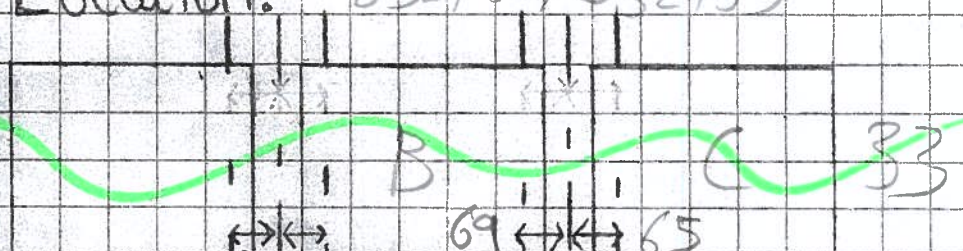
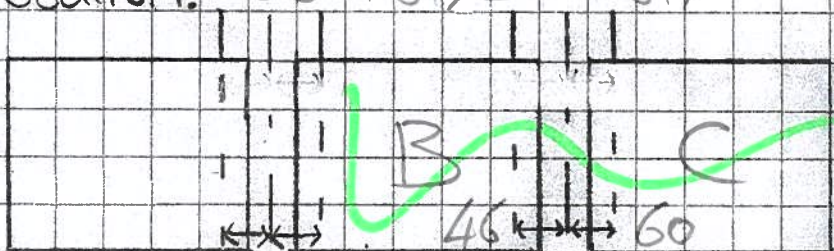

Z0

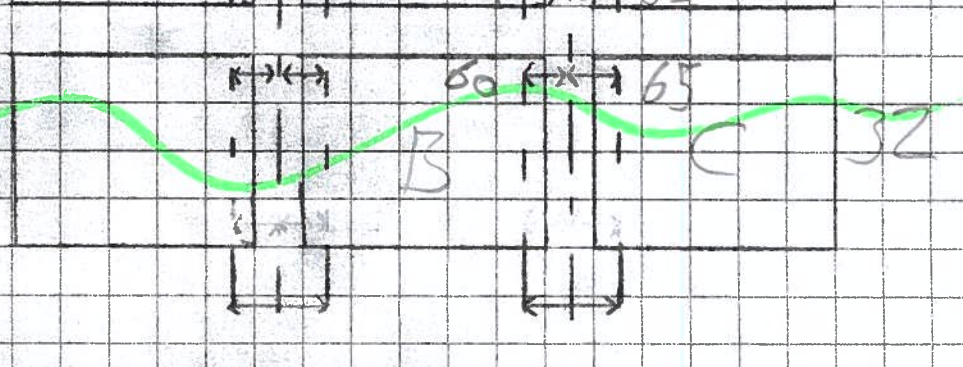
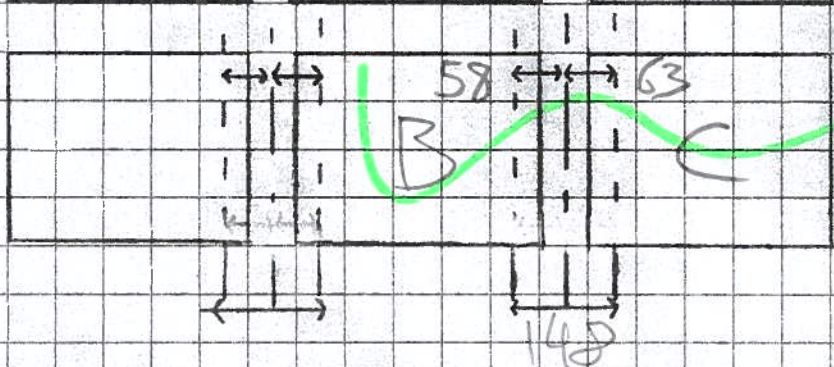

Page 74

Location: F20+21, G20+21,

Location:

Z1

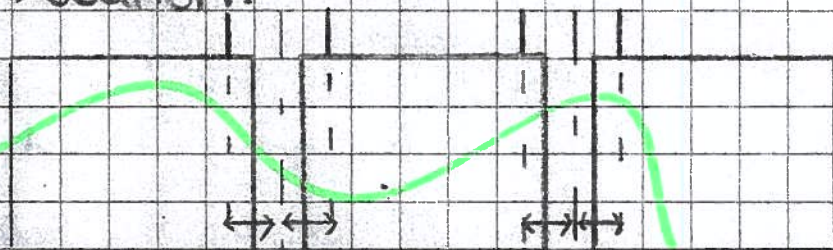
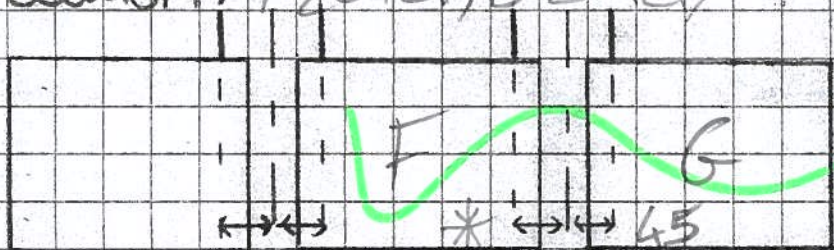

Z0

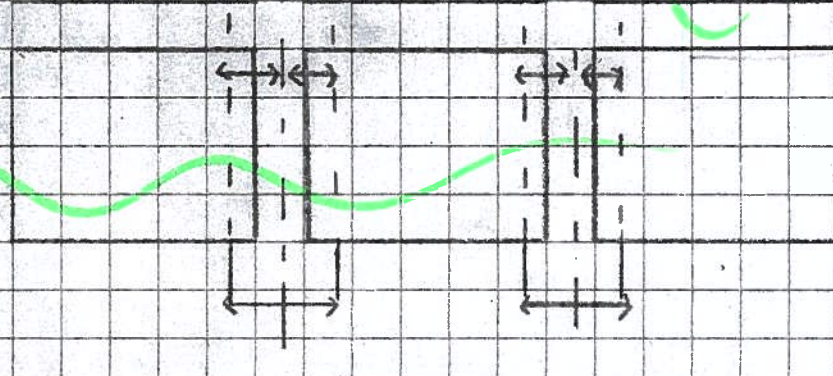
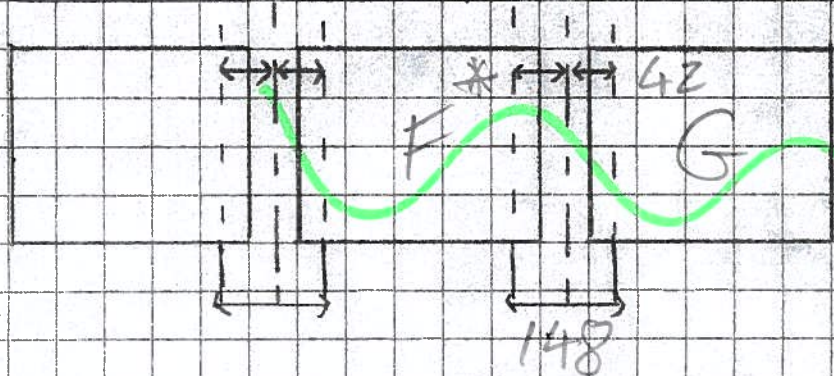

Rappel - End Bearing Survey results

	A	B	C	D	E	F	G	H	I	J	K	L	M	N
1														
2				64 68	75 70	* *	62 56	37 84	48 49					
3				66 69	78 75	52 *	66 65	30 80	55 66					
4														
5														
6														
7														
8														
9				* *	71 74	30 *	* 50	68 63	73 44	46	57			
10				* *	50 75	47 *	* 50	78 70	69 54	43	41			
11														
12														
13														
14														
15														
16														
17														
18				73	* 66	42 62	77 65	56 89	67 75	52 56	70 70			
19				* 41	60 62	67 54	59 77	65 54	75 73	58 55	75	74		
20				70 68	65 80		42			59 74				
21				75 70	50 62		45			55 77				
22				74 68										
23				35 68			39 53			68 57				
24							51 51			68 57				
25														
26				60	71					63 75				
27										72	*			
28				85 64	75	* 69	44 75	66 55	59 65	25 49	58 53	77 58	65 60	
29				83 63	77 70	63 62	40 68	51 54	68	78 54	76 38	79 68	68 72	
30													70 31	
31				58 63										
32				46 60		62 61	44 56	72 65	67 57	75 41	74 42			
33						46 40	44 65	65 70	68 69	* 60	77 55			
34														
35														
36														
37				66 49	79 56		59 50	65 63	55 54	62 *	56 64	75 67		
38				54 60	76 55		57 72	55 81	56 64	36 *	51 69	76 58		
39														
40														
41														
42														
43														
44														
45				82 53	71 63	72 76	84 49	67	51 55	71 *	83 52	53 72	44 78	33 42
46				38 61	75 58	62 73	70 59	72 69	61 59	86 *	67 79	62 54	92 42	38 60
47														56 57
48														
49				53 51	50 *	67 66								
50				77	35 *	59 50								
51						58 75	66 82		44 70	* 73				
52						63 68	64 80		47 71	66 45	66 63	56 *	39 65	69 74
53										81 40	70 61	59 *	60 69	69 44
54														49 26
55														
56														
57														
58														
59														
60														
61														
62														
63														
64														
65														
66														
67														
68														
69														
70														
71														
72														
73														
74														
75														
76														
77														
78														
79														
80														
81														
82														

Please note:
 All end bearing values displayed on the adjacent table are measured in millimetres (mm).
 Table adjacent displays end bearing measurements in format as received by Rappel. For visual purposes, this data has been orientated to reflect the main key plan in the written report.

Analysis of results		
Measurement	Value	Unit
Maximum end bearing	92	mm
Minimum end bearing	25	mm
Overall average end bearing	61.64082687	mm

Planks surveyed for end bearing



Rappel - End Bearing Survey results

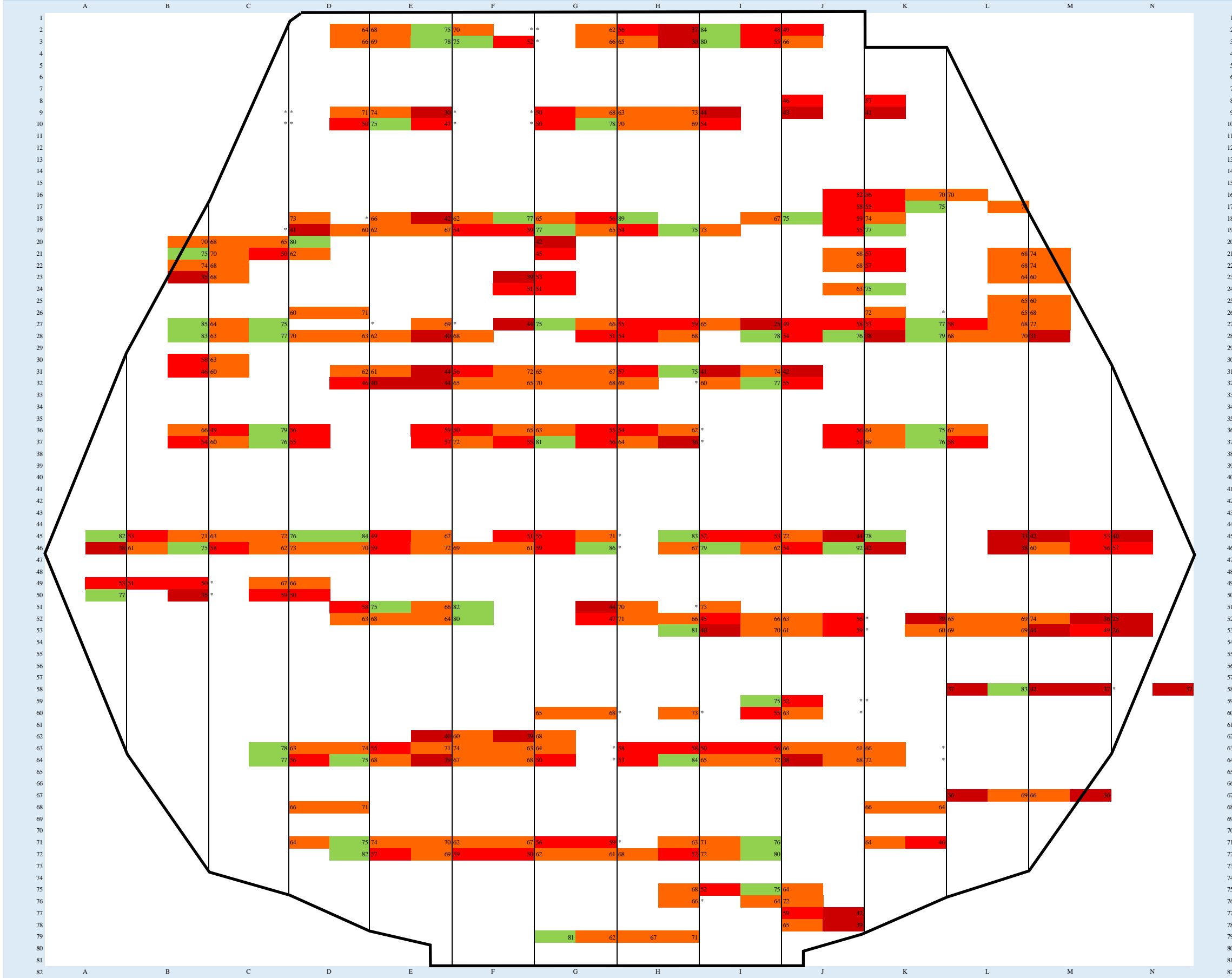

Colour code	End bearing measurement range
■	< 45mm
■	45mm ≤ x < 60mm
■	60mm ≤ x < 75mm
■	75mm ≤

Please note:
 All end bearing values displayed on the adjacent table are measured in millimetres (mm).
 Table adjacent displays end bearing measurements in format as received by Rappel. For visual purposes, this data has been orientated to reflect the main key plan in the written report.



Appendix B

RAPPEL SURVEY DATA – INTRUSIVE SITE INVESTIGATIONS



Location: -G60

Measurement = mm

Gmm Ref'd

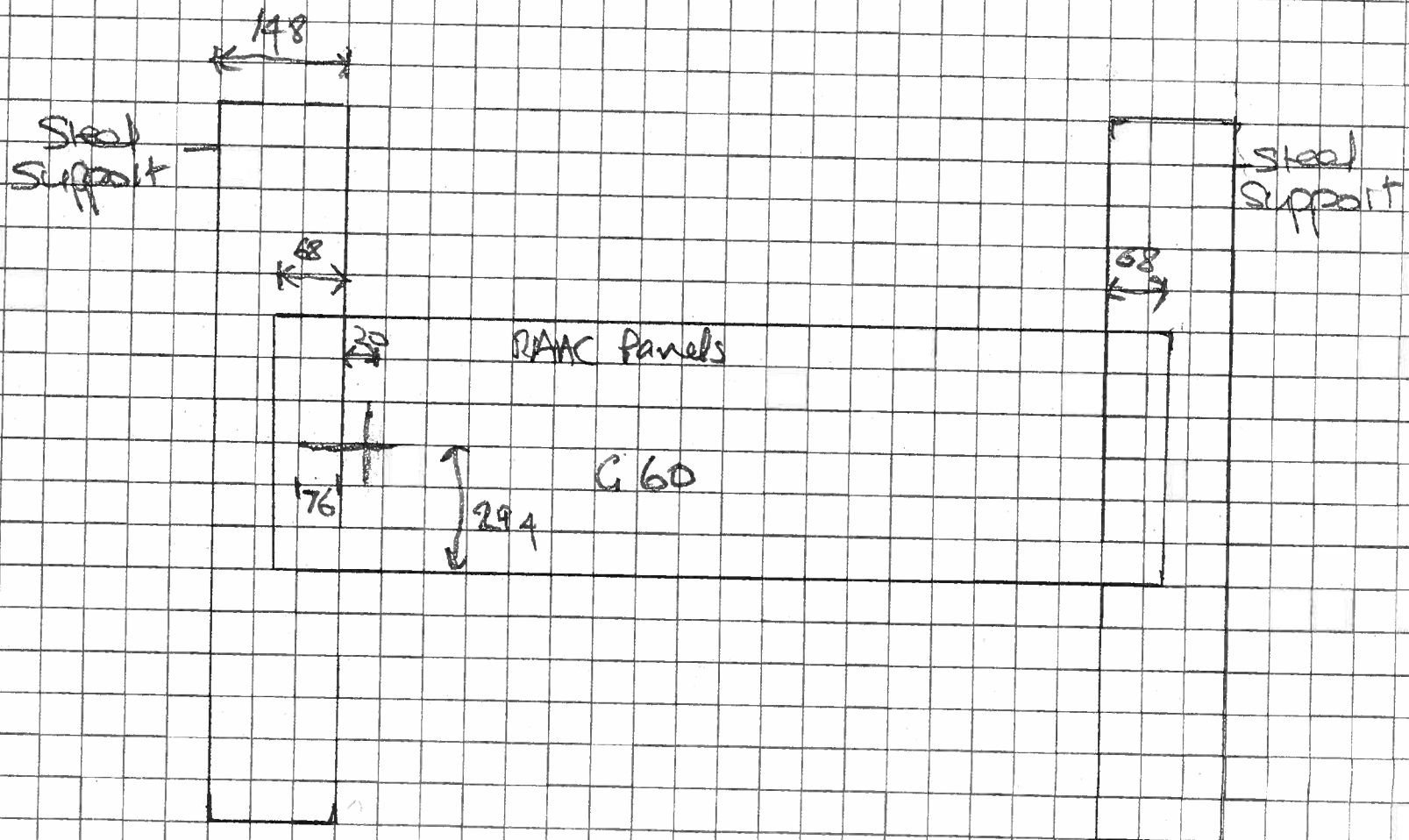

Page 78

Location - D68

5-6 mm rebar

Measurements = MM

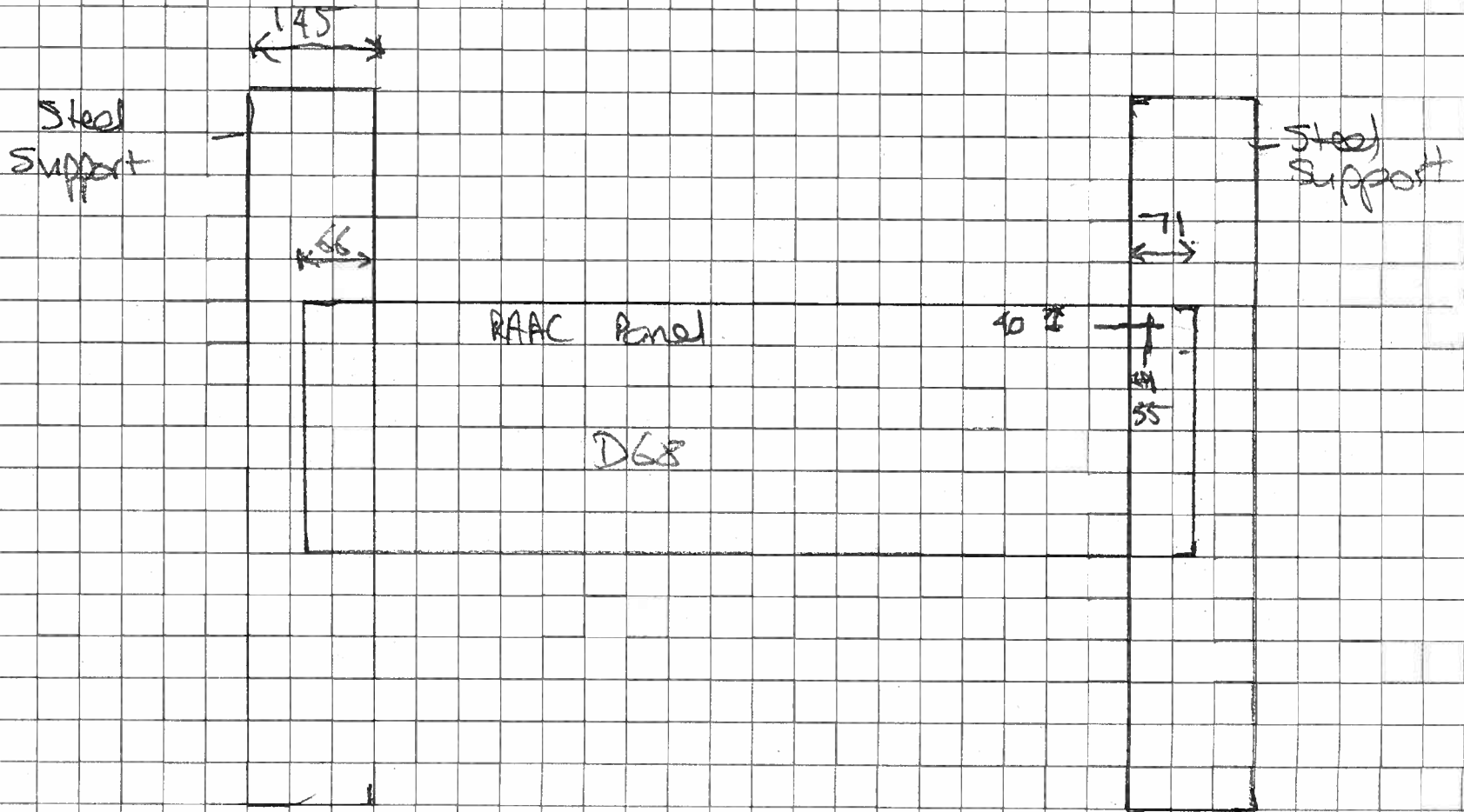

Location: - K 68

Gunn, elgar

MEASUREMENTS - mm

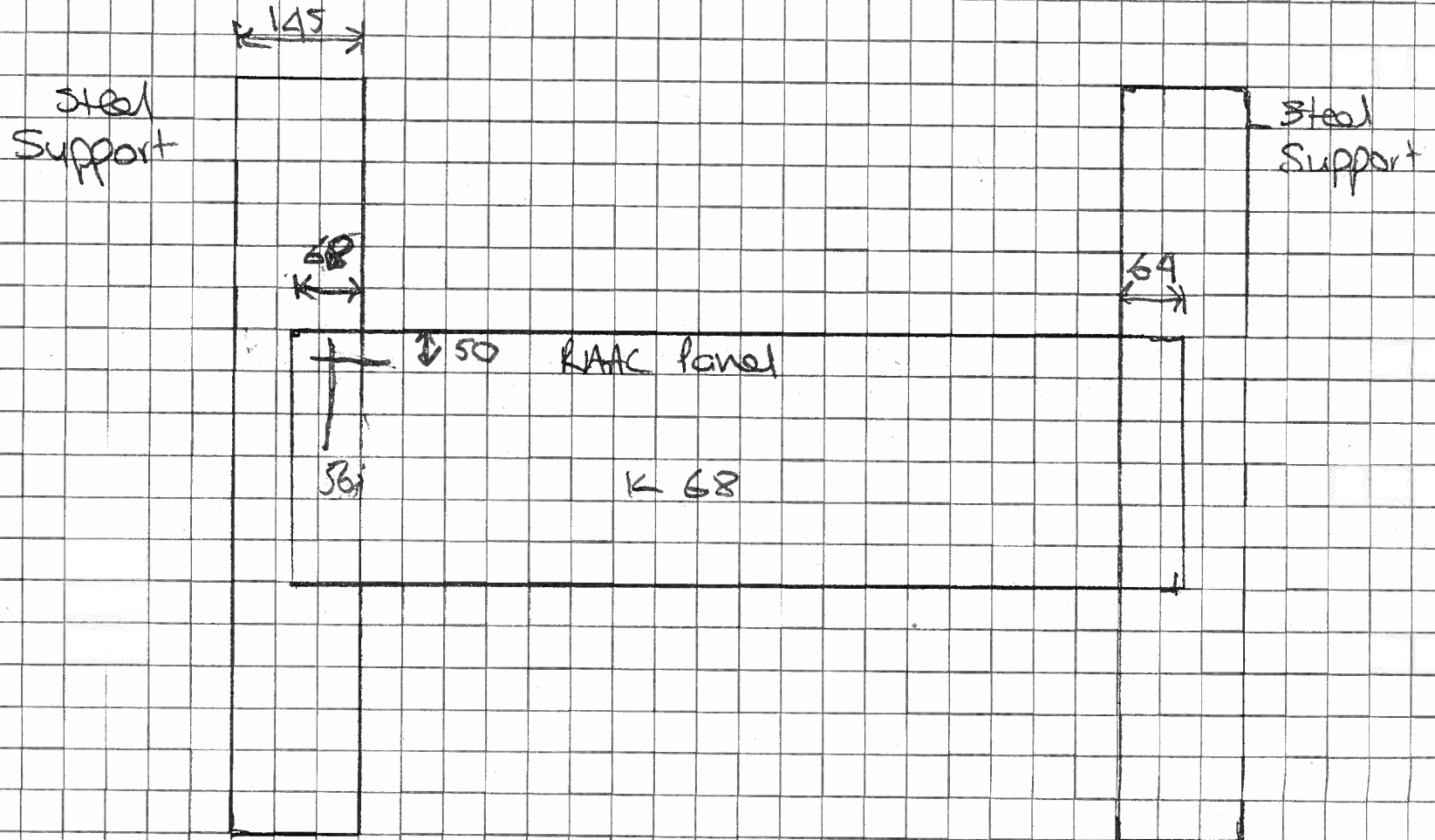

Location - K71

6 mm rebar?

Measurements = mm

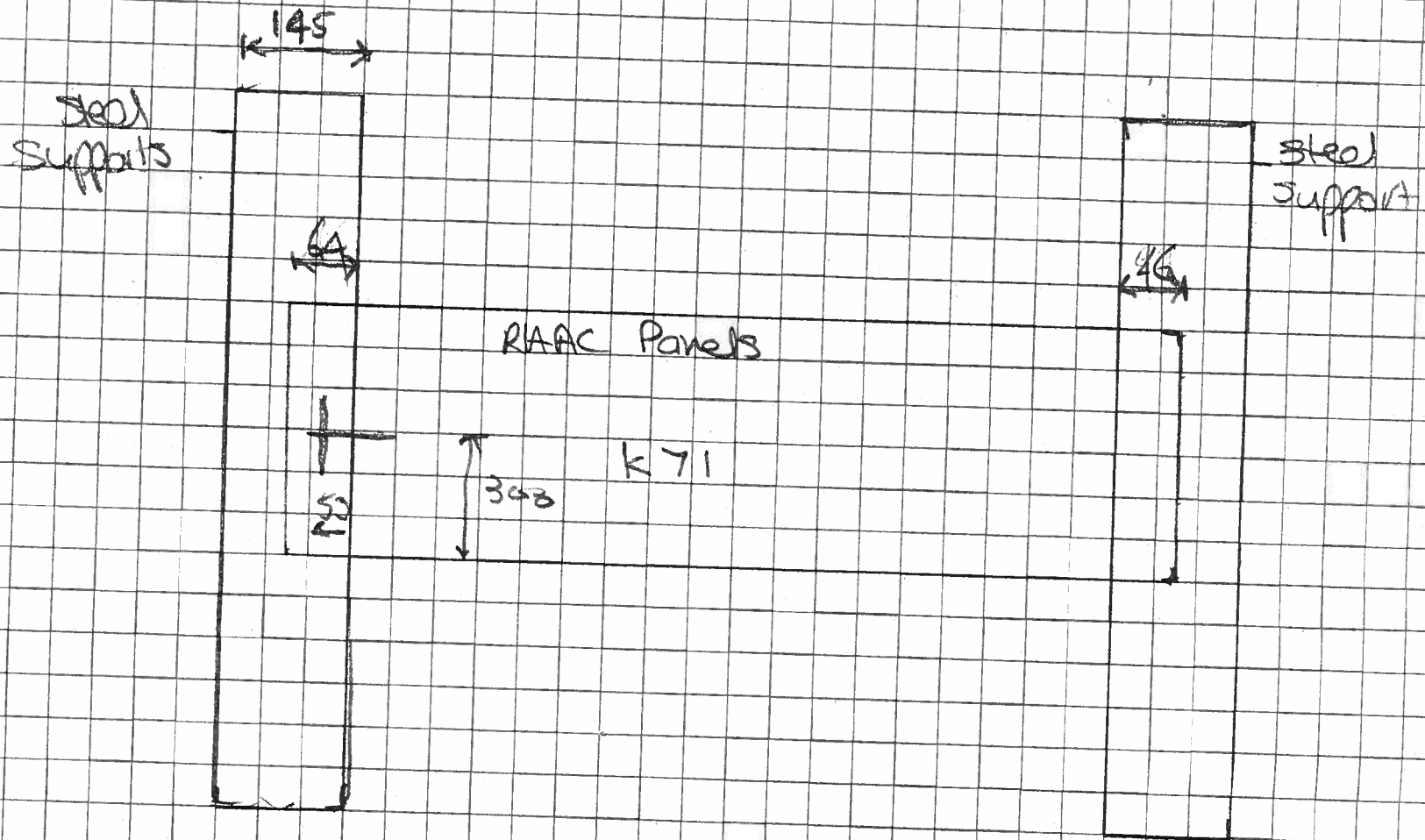

Page 81

Location: - K26

Measurements = mm

6 mm rebar

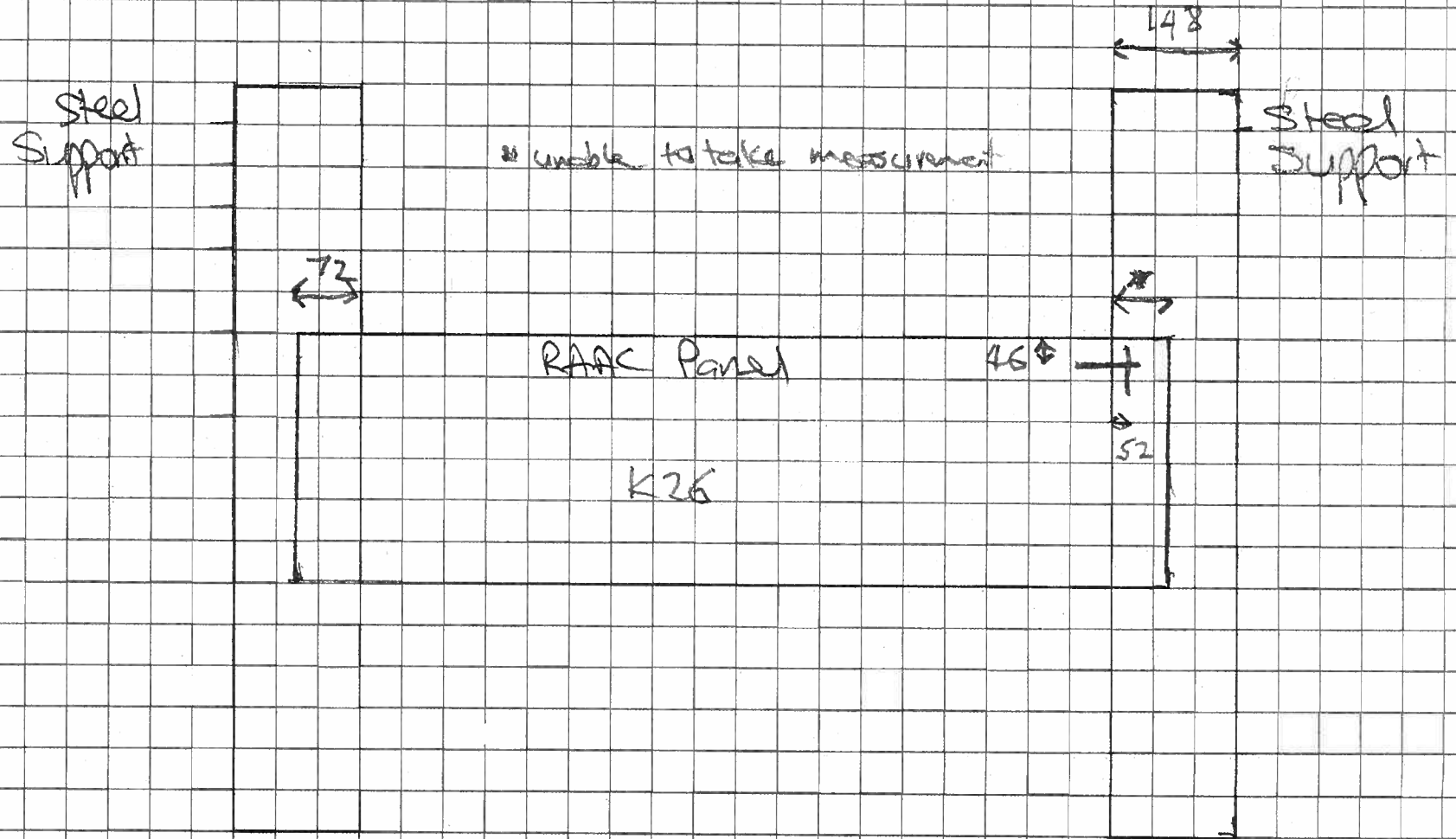

Location: - D26

measurements = mm

6 mm rebar

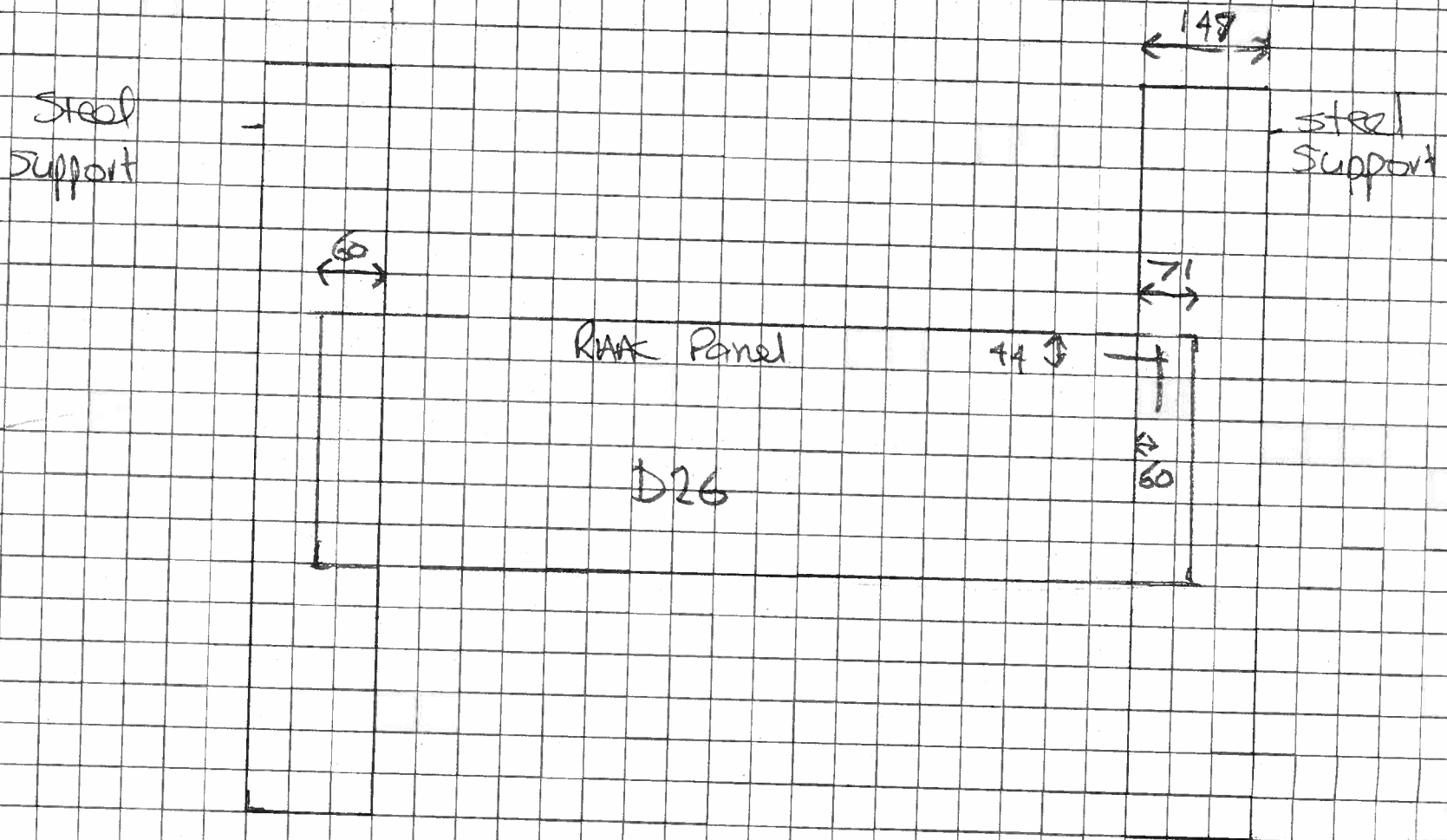

Location - D71

Gum Rehab

Measurements = MM

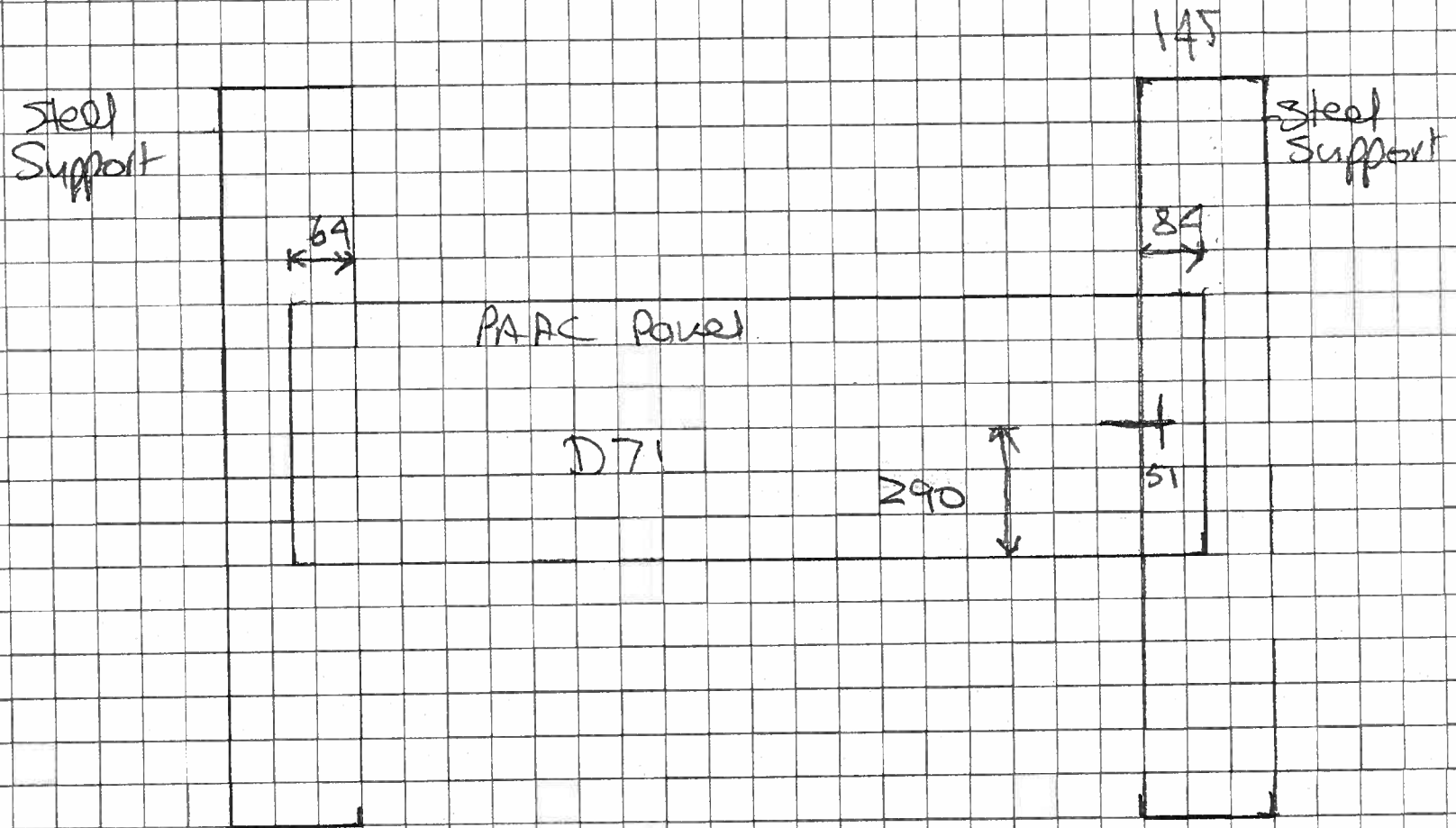

Page 84

Location = H79

Measurements = mm

6mm rebar

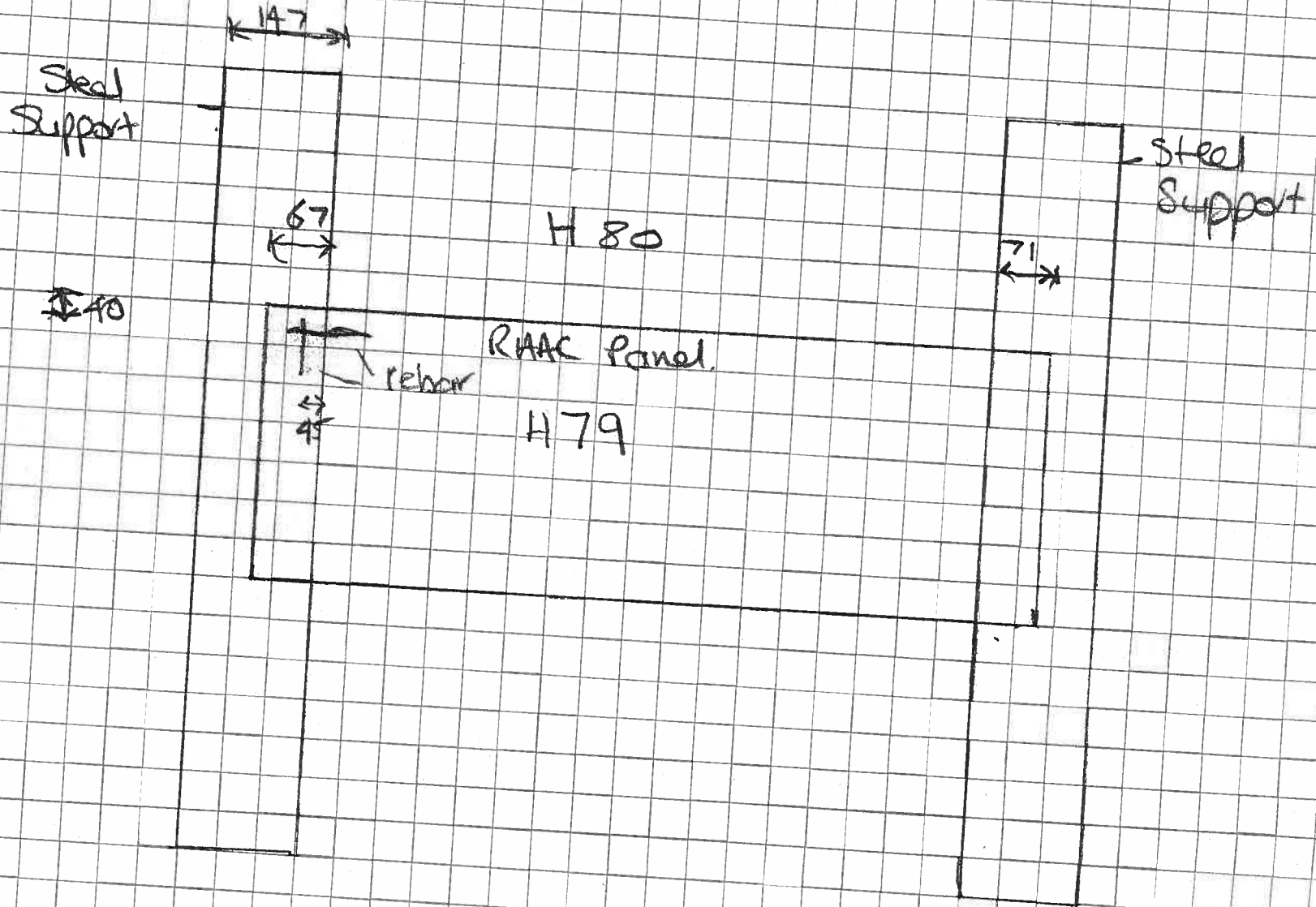

Location - H60

6mm repair

Measurement = mm

Page 86

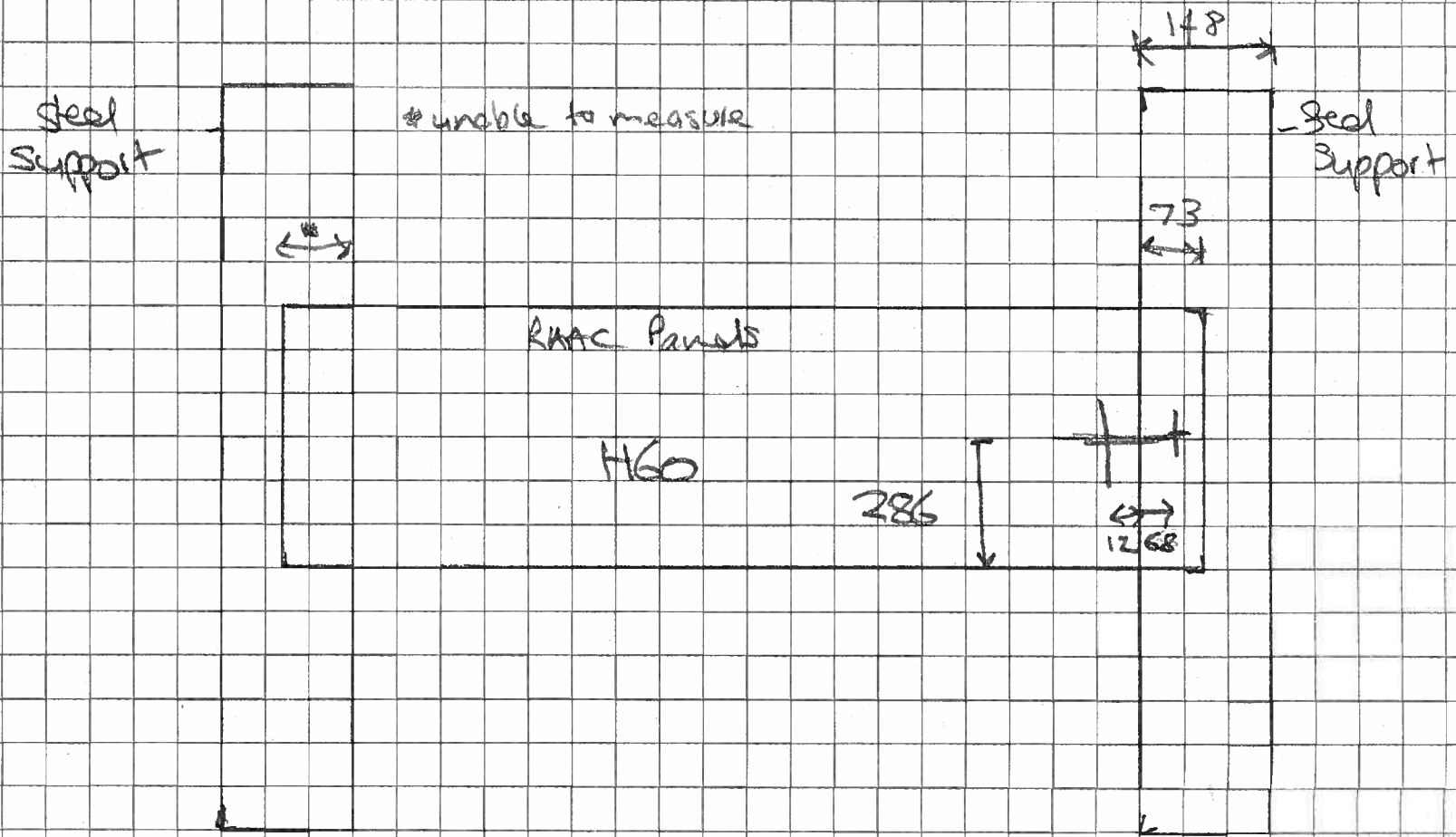



1 Capital Quarter
Tyndall Street
Cardiff
CF10 4BZ

wsp.com

This page is intentionally left blank

By virtue of paragraph(s) 14, 16 of Part(s) 4 and 5 of Schedule 12A of the Local Government Act 1972.

Document is Restricted

This page is intentionally left blank

Cardiff Council Single Impact Assessment



1. Details of the Proposal

What is the proposal?	
Title:	For a new tenant to run St David's Hall. Academy Music Group would like to commit to a 45-year property lease to operate the venue.

Is this a new proposal or are you amending an existing policy, strategy, project, procedure or service?	
New	<input type="checkbox"/>
Existing	<input checked="" type="checkbox"/>

Directorate/Service Area:	
Economic Development	

Who is developing the proposal?	
Name:	Chris Barnett
Job Title:	Operational Manager for Major Projects

Responsible Lead Officer (Director or Assistant Director):	
Director of Economic Development, Neil Hanratty	

Cabinet Portfolio:	
Culture, Parks and Events	

The Single Impact Assessment (SIA) can be strengthened as time progresses, helping shape the proposal. Version control will provide a useful audit trail of how the SIA has developed. Draft versions of the assessment should be retained for completeness, however only the final version will be publicly available. Draft versions may be provided to regulators if appropriate.

Version	Author	Job Title	Date
1	Chris Barnett	OM Major Projects	11/06/2023
2	Updates following feedback from Equalities, Child Friendly & Welsh Language teams		26/06/23
3			

2. Overview of the Proposal

What action is the Council considering and why?

Please provide an outline of the proposal.

The action the Council is taking is to secure a future for St David’s Hall/ Neuadd Dewi Sant, including protecting the classical and community music programme that St Davids Hall/Neuadd Dewi Sant has become renowned for. In addition to this, the ambition is to improve the contemporary music offer, ensuring that the people of Cardiff, Wales and beyond can access the most relevant contemporary music, bands and acts synonymous with an Academy offer in the Capital of Wales.

This action is being taken because the venue requires tens of millions of pounds of investment, improved front of house facilities and an improved music and community programme. After 10+ years of austerity, the Council is facing an additional £24million budget gap this year, therefore is committed to a positive course of action to secure the future of this nationally important venue.

In December 2022, a report to Cabinet stated that the Council was considering an unsolicited offer from AMG to take over operation of St David’s Hall without subsidy and to take away all the building’s risks and liabilities from the Council. The report stated that AMG has given a firm commitment to work to enhance the venue’s reputation as the National Concert Hall of Wales by continuing to maintain and develop the classical music programme to protect the classical series. This would be alongside the introduction of AMG’s Academy music venue. In the proposed deal both a classical and community programme would be protected, which includes supporting important events and activity relating to culture in Wales and Welsh culture itself. Please note this is a property lease transaction and not the sale of the Property. Also note, this property transaction has been developed in line with legal advice from Kings Counsel on what can legally be included as part of transaction on this kind.

The Outline Business Case sets out that AMG will operate the venue without subsidy whilst also investing in the building and protecting the classical programme. AMG can achieve this, where the Council has been unable to, by introducing their Academy product to St David’s Hall. This will transform the venue’s commercial programme and significantly improve commercial revenue.

The December 2022 report to Cabinet set out that, if the Council is minded to proceed with the proposed contract, then the Council intend to publish a VEAT notice (Voluntary Ex-Ante Transparency Notice) to advise the market of the offer that has been made, to enable other suppliers to challenge the decision.

A question on the future management of St David's Hall was included in the consultation on the 2023/24 Budget Proposals. The Budget 2023/24 report to Cabinet, in March 2023, highlighted that the budget consultation found that, in response to a question seeking views on a new partner to run St David's Hall, the responses received were 59% in support and 26% against.

Additional to this process to ensure best value is achieved, in April 2023, a marketing exercise took place, inviting offers from experienced and qualified theatre, arts and venue services organisations interested in leasing and operating St David's Hall.

The marketing exercise has concluded; no bids were received that would take on the building liability and the classical commitments.

The Council subsequently published a VEAT notice as planned.

Review of SIA – October 2023

In July 2023, Cabinet approved a report to conclude negotiations with AMG, complete the lease and business sales agreement and associated documents with AMG for St David's Hall and authorise the transfer of employees to AMG under the Transfer of Undertaking (Protection of Employment Regulations 2006) (TUPE).

Since the July Cabinet meeting, there has been increased awareness and Health & Safety Exec guidance around RAAC Planks which has led to the Council closing the building whilst intrusive survey work was undertaken for the roof. This has confirmed the presence and the status of the RAAC planking. The risk rating of the roof will now require the Council to close the building until works are undertaken to address the identified risks. AMG have indicated they wish to take forward the arrangement subject to finding a viable solution for the replacement of the roof. This will require a further Cabinet Report to agree the Agreement for Lease which would be the precursor to AMG entering the Agreement for Lease. This review takes into consideration any changes to the impacts previously identified.

What are the costs and/or savings?

What will the proposal cost and how will it be funded?

How might costs be reduced through involvement and collaboration, across Cardiff Council and/or with external stakeholders?

Are there savings and how will these be realised?

The investment needed in St Davids Hall is estimated at £38million pounds. The proposed new tenant would need to agree that they commit to manage and, where relevant repair the defects identified over the course of the proposed 45-year lease.

A new tenant would also remove the annual subsidy needed for St David's Hall from the Council. Currently there is a budgeted operating subsidy of £688,700 per annum, which is regularly exceeded, with subsidy levels of £1m+

Review of SIA – October 2023

The risk rating of the roof will now mean that an action plan will need to be in place and appropriate works undertaken before the building can be reopened. AMG are still committed to invest in St. David's Hall and wish to proceed with the proposed transaction and thus this would bring forward planned reparatory works by AMG as new tenant.

3. Impact Assessments

Which impact assessments do you need to complete to support your proposal?

Impact Assessment	Page	To be completed: Y/N
A. Equality Impact Assessment	5	Y
B. Child Rights Impact Assessment	12	Y
C. Welsh Language Impact Assessment	16	Y
D. Habitats Regulations Assessment		N
E. Strategic Environmental Assessment		N
F. Data Protection Impact Assessment		N
G. Health Impact Assessment		N

For further information on all the above impact assessments including who to contact for advice, please visit the [Policy Portal](#).

A: Equality Impact Assessment

Guidance in completing this assessment can be accessed [here](#). Please consult the Equality Team for any further assistance with completing this assessment EqualityTeam@cardiff.gov.uk

Impact on the Protected Characteristics

Age

Will this proposal have a **differential impact [positive/negative]** on younger/older people?

	Yes	No	N/A
Up to 18 years	✓	✓	
18 - 65 years	✓	✓	
Over 65 years	✓	✓	

Please give details/consequences of the differential impact, and provide supporting evidence, if any.

The proposed new tenant, Academy Music Group (AMG) seeks to expand the diversity of acts/events by bringing an Academy product to the city centre which would have a positive impact to all age groups. An Academy product would bring to St. David's Hall new and different music genres, acts and performances that would not have taken place at the venue previously.

The existing overall programme at St David's Hall, needs to be developed to reach more of our diverse communities in Cardiff and Wales and younger audiences to better reflect the demographic of the city. The plan to optimise the programme to reflect this would better serve cultural equality in Cardiff and Wales.

AMG also offer a commitment to developing and enhancing the classical and community programme. This will be supported by a Classical Music Stakeholders board, that will work to develop the Classical and Community programme at St David's Hall. As well as developing the programme, the group will work to protect and sustain what concerts are culturally important to communities in Cardiff and Wales.

What action(s) can you take to address the differential impact?

No action required.

Disability

Will this proposal have a **differential impact [positive/negative]** on disabled people?

	Yes	No	N/A
Hearing Impairment	✓		
Physical Impairment	✓		

Visual Impairment	✓		
Learning Disability		✓	
Long-Standing Illness or Health Condition	✓		
Mental Health		✓	
Substance Misuse		✓	
Other		✓	

Please give details/consequences of the differential impact, and provide supporting evidence, if any.

The AMG proposal would result in significant investment to the building thus improving and modernising front of house & communal areas.

Investment to these areas of the building, would likely result in improvements to physical access, making it easier for those with physical impairments / long standing health conditions and potentially to those with visual and hearing impairments, with the installation of for example, improved lighting.

What action(s) can you take to address the differential impact?

Accessibility improvements.

Gender Reassignment

Will this proposal have a **differential impact [positive/negative]** on transgender people?

	Yes	No	N/A
Transgender People (People who are proposing to undergo, are undergoing, or have undergone a process [or part of a process] to reassign their sex by changing physiological or other attributes of sex)	✓		

Please give details/consequences of the differential impact, and provide supporting evidence, if any.

AMG investment the building would result in significant upgrade and modernisation of communal areas. This presents an opportunity for the provision of gender-neutral facilities which would have a positive impact.

AMG are also committed to providing a more contemporary programme, better reflecting audiences of today, booking more diverse artists and musicians that would have a wide appeal to LGBTQ+ audiences.

What action(s) can you take to address the differential impact?

Accessibility improvements. Expanded provision and diversity of performances.

Marriage and Civil Partnership

Will this proposal have a **differential impact [positive/negative]** on marriage and civil partnership?

	Yes	No	N/A
Marriage		✓	
Civil Partnership		✓	

Please give details/consequences of the differential impact, and provide supporting evidence, if any.

No differential impact.

What action(s) can you take to address the differential impact?

No action required.

Pregnancy and Maternity

Will this proposal have a **differential impact [positive/negative]** on pregnancy and maternity?

	Yes	No	N/A
Pregnancy		✓	
Maternity		✓	

Please give details/consequences of the differential impact, and provide supporting evidence, if any.

No differential impact.

What action(s) can you take to address the differential impact?

No action required.

Race

Will this proposal have a **differential impact [positive/negative]** on the following groups?

	Yes	No	N/A
White	✓		
Mixed / Multiple Ethnic Groups	✓		
Asian / Asian British	✓		
Black / African / Caribbean / Black British	✓		
Other Ethnic Groups	✓		

Please give details/consequences of the differential impact, and provide supporting evidence, if any.

AMG seeks to expand the diversity of acts/events by bringing an Academy product to Cardiff/Wales. This programme will include music genres not regularly part of the St. David's Hall offer. Expanding appeal to community groups that don't currently feel the venue is for them and therefore this would result in a positive impact in terms of access and diversity of programme.

What action(s) can you take to address the differential impact?

Expanded provision and diversity of performances.

Religion, Belief or Non-Belief

Will this proposal have a **differential impact [positive/negative]** on people with different religions, beliefs or non-beliefs?

	Yes	No	N/A
Buddhist	✓		
Christian	✓		
Hindu	✓		
Humanist	✓		
Jewish	✓		
Muslim	✓		
Sikh	✓		
Other	✓		

Please give details/consequences of the differential impact, and provide supporting evidence, if any.

A positive impact may be made with an expansion in programme diversity. This could result in a greater attendance / participation from all groups.

What action(s) can you take to address the differential impact?

Expanded provision and diversity of performances.

Sex

Will this proposal have a **differential impact [positive/negative]** on men and/or women?

	Yes	No	N/A
Men		✓	
Women		✓	

Please give details/consequences of the differential impact, and provide supporting evidence, if any.

No differential impact.

What action(s) can you take to address the differential impact?

No action required.

Sexual Orientation

Will this proposal have a **differential impact [positive/negative]** on the following groups?

	Yes	No	N/A
Bisexual	✓		
Gay Men	✓		
Gay Women/Lesbians	✓		
Heterosexual/Straight	✓		

Please give details/consequences of the differential impact, and provide supporting evidence, if any.

AMG are also committed to providing a more contemporary programme, better reflecting audiences of today, booking more diverse artists and musicians that would have a wide appeal to LGBTQ+ audiences.

What action(s) can you take to address the differential impact?

Expanded provision and diversity of performances.

Socio-economic Duty

Is the change anticipated to reduce or contribute to inequality of outcome as a result of socio-economic disadvantage? (e.g. will the change negatively impact on those on low-incomes or those living in deprived areas)

	Yes	No	N/A
Socio-economic impact	✓		

Please give details/consequences of the differential impact, and provide supporting evidence, if any.

Ticket pricing structures may need to be looked at, accessing what is commercially viable. AMG are sensitive to what is affordable for diverse communities and have agreed to work with stakeholders to ascertain a reasonable ticket pricing offer.

What action(s) can you take to address the differential impact?

Work with partner stakeholders on ticket pricing arrangements. The new tenant and Music Stakeholders group will work to secure affordable ticket pricing and support packages, to ensure fair inclusion for those from less affluent backgrounds.

Welsh Language

Will this proposal have a **differential impact [positive/negative]** on the Welsh language?

	Yes	No	N/A
Welsh language			

Please give details/consequences of the differential impact, and provide supporting evidence, if any.

Please refer to the Welsh Language Impact Assessment.

What action(s) can you take to address the differential impact?

Please refer to the Welsh Language Impact Assessment.

Consultation and Engagement

What arrangements have been made to consult/engage with the various equalities groups?

The 2023/24 Budget Proposals consultation in March posed a question to citizens to seek views on the proposal for St David’s Hall to be run under an alternative operating model whereby the Council would secure a long-term lease arrangement with a tenant, who would be required to maintain a classical and community programme and have an obligation to keep the premises open, safe and operational.

There were a total of 5,932 responses of which there respondents from a wide range of demographic groups. The results were overall supportive of the proposal with 58.6% of respondents (three in five respondents) supporting the proposal, this was double the proportion of those against (25.7%).

The below graph shows a summary of data gathered of responses from impacted groups:

St. David's Hall: Do you support this proposal?

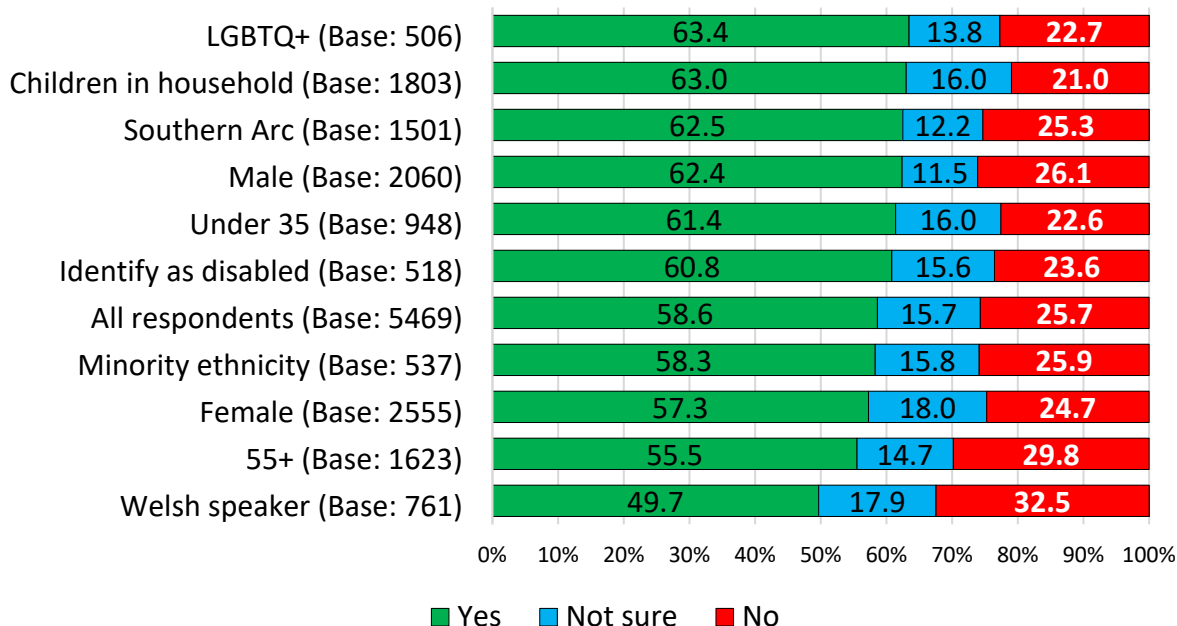

Notably, there was strong support for the proposals by those in a number of equalities groups; those identifying as LGBTQ+ (63.4%) and those with children in their household (63.0%) were most likely to support the proposal for St David’s Hall. Welsh speakers showed the highest level of opposition (32.5%), however close to 50% of respondents who identified as Welsh supported the proposal. A Welsh language Impact Assessment has been undertaken (please refer to Section C of this document).

There was no correlation with support for this proposal and level of deprivation:

St. David's Hall: Do you support this proposal?

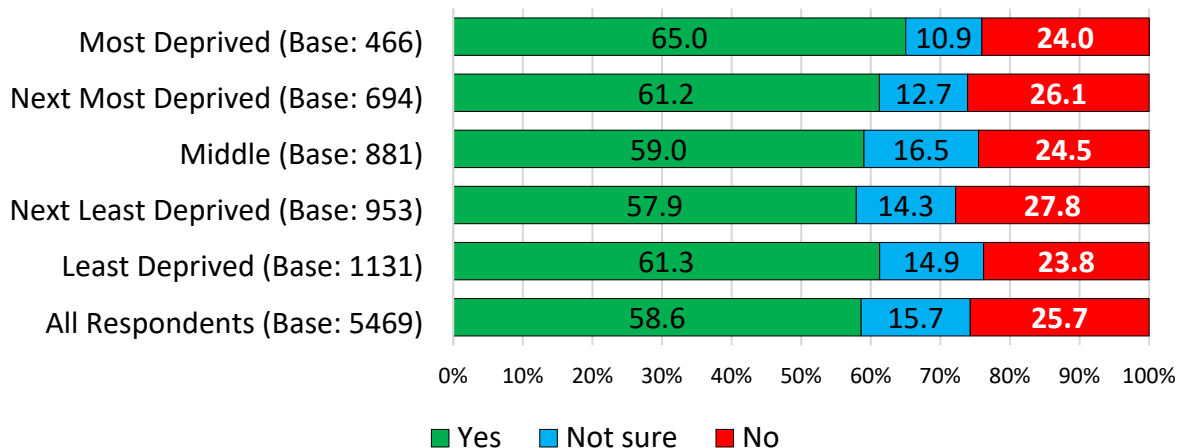

The question regarding the future proposal for St. David’s Hall was also posed in a Youth Survey where questions were tailored for a younger audience and promoted via the Council’s schools and Child Friendly City engagement channels. Almost two-thirds (62.6%)

of those taking part in the Youth Survey supported the proposal for a long-term lease arrangement, a quarter (25.2%) were unsure, whilst almost one in eight (12.2%) opposed it. This demonstrates higher levels of support than the city-wide average. Some of the concerns highlighted by young people were around whether there would be a reduction in community events, price increases and a reduction in overall use of the venue.

Summary of Actions (Listed in the sections above)

	Actions
Age	No action required.
Disability	Accessibility improvements
Gender Reassignment	Accessibility improvements. Expanded provision and diversity of performances.
Marriage & Civil Partnership	No action required.
Pregnancy & Maternity	No action required.
Race	Expanded provision and diversity of performances
Religion/Belief	Expanded provision and diversity of performances
Sex	No action required
Sexual Orientation	No action required
Socio-economic Impact	Work with partner stakeholders on ticket pricing arrangements
Welsh Language	See Welsh Language Impact Assessment below
Generic/ Over-Arching (applicable to all the above groups)	

Review to EqIA – October 2023

Whilst in the longer term all the above impacts, mitigations and actions apply, there is a negative impact to all groups in the short term as the full programme of events and performances will not take place at St. David's Hall for the duration of its closure.

In terms of mitigation to this, the Council will work with stakeholder partners and promoters to find alternative venues for performances to be hosted or defer performances to a later date, wherever possible.

Next Steps

Any recommendations for action that you plan to take as a result of this Equality Impact Assessment (listed in Summary of Actions) should be included as part of your Service Area's Business Plan to be monitored on a regular basis.

On completion of this Assessment, please ensure that the form is submitted to the Equality Team mailbox so that there is a record of all assessments undertaken in the Council EqualityTeam@cardiff.gov.uk

B: CHILD RIGHTS IMPACT ASSESSMENT (CRIA)

Information or assistance in completing the CRIA, please email the Child Friendly Cardiff Team ChildFriendlyCardiff@cardiff.gov.uk



STAGE 1: PURPOSE/SCOPE

1. **What is the policy/strategy/project/procedure/service?
Summarise its overall aims and any aims specific to children.**

See Overview in part 2.

St. David's Hall offers a number of events and performances to children and young people, often offering the opportunity for young peoples' first public concert hall performance. We have evidence that many young people have gone on to enjoy significant success in the music industry after experiencing positive reactions at these concerts.

For 40 years, St David's Hall has offered performance opportunities for Youth Orchestras, School Orchestras, Young Choirs and community music organisations. We plan to protect and optimise this activity, through the Classical Stakeholders Advisory Boards MoU, which is tasked with developing youth music opportunities at St David's Hall.

As well as through our Cardiff Council and associated schools' music service provision, Cardiff Council will continue to employ staff members of Arts Active, who will transfer to our Council Education team, and develop work to align with the Cardiff Music Strategy and music education objectives.

The Arts Active Trust is an independent Trust set up to support the work of the Arts Active team. The Arts Active team are employed by Cardiff Council to deliver outreach programmes to promote the music and arts activities at St David's Hall and with other partners, to engage with the communities of Cardiff and beyond, to encourage interest in and the appreciation of music, performing arts and multi-disciplinary arts projects through participation, education and audience development.

Cardiff Council will be signing an MoU with the new tenant and a Classical Stakeholders Advisory Board, that will oversee youth programming development in line with the aspiration of optimising the overall classical and community programme at St David's Hall.

2. Please select the groups of children and young people who will be directly and/or indirectly impacted. Please review after completing the form.

<input checked="" type="checkbox"/> Protected Characteristics	<input checked="" type="checkbox"/> EOTAS
<input checked="" type="checkbox"/> Young Parents	<input checked="" type="checkbox"/> Gypsy Travellers
<input checked="" type="checkbox"/> Children of Single Parents	<input checked="" type="checkbox"/> Asylum Seekers
<input checked="" type="checkbox"/> Southern Arc Children	<input checked="" type="checkbox"/> BAME Community
<input checked="" type="checkbox"/> Children of Deaf Parents	<input checked="" type="checkbox"/> Care Experienced
<input checked="" type="checkbox"/> Young Carers	<input checked="" type="checkbox"/> Pre-School
<input checked="" type="checkbox"/> Primary School	<input checked="" type="checkbox"/> Secondary School
<input checked="" type="checkbox"/> Welsh First Language	<input checked="" type="checkbox"/> Non-Native Speakers of English
<input checked="" type="checkbox"/> Set Locality	<input checked="" type="checkbox"/> Citywide
<input checked="" type="checkbox"/> LGBTQ+	<input checked="" type="checkbox"/> ALN
<input checked="" type="checkbox"/> Youth Justice	Other - Click or tap here to enter other identified groups

STAGE 2: BUILD AND ASSESS

The General Principles of the UNCRC (United Nations Convention on the Rights of the Child) are at the heart of a child rights approach. [This link](#) will take you to a page on our website with a full list of Children’s Rights and supporting information. [Click here](#) to access a list of articles grouped into common themes.

3. What is the likely/ actual impact of the proposal on children’s rights? Is it positive, negative, or neutral?

<i>Describe the Impact</i>	<i>Impacted UNCRC Articles</i>	<i>Impact Scale</i>	<i>How to mitigate impact (if negative)</i> i - additional info
The commitment to work with schools through our Music Services teams, Youth Orchestras and youth music organisations, as well as Arts Active Trust, all who typically provides art-related educational activities, aligns with the UNCRC's goal of education, which includes the development of a child's personality, talents, and mental and physical abilities to their fullest potential.	Article 29 (Goals of Education)	Positive	Click or tap here to add a mitigation.
The proposal's commitment to preserve a robust youth classical programme, accommodate community events, and introduce the AMG Academy music product will enrich local cultural offerings. This helps to ensure that children have access to a wide range of	Article 31 (Leisure, Play, and Culture)	Positive	Click or tap here to add a mitigation.

cultural, artistic, and recreational activities, in line with Article 31. Particularly enhancing a more diverse music programme that will better appeal to today's young people and more relevant to possible music performance opportunities.			
The group will work with the Cardiff Music Board, who are tasked with creating opportunities for young people from disadvantaged and working-class backgrounds, to identify talent from these backgrounds and work with organisations to nurture diverse talent to develop, produce and perform.	Article 29 (Goals of Education)	Positive	Click or tap here to add a mitigation.
We recognise that potential increase in ticket prices due to the venue's transition to a commercial operation could make cultural events less accessible for some children, particularly those from less affluent backgrounds, conflicting with the intention of Article 31.	Article 31 (Leisure, Play, and Culture)	Negative	The new tenant and the Classical Music Stakeholders group, will work to secure affordable ticket pricing and support packages, to ensure fair inclusion for children from less affluent backgrounds.

STAGE 3: VOICE AND EVIDENCE

4. How do you plan to review the policy/ strategy/ project/ procedure/ service to ensure that it respects, protects and fulfils children's rights? [i - additional info](#)

Cardiff Council are retaining an active role on the Classical Stakeholders Advisory group with the new tenant. Council Officers will work closely with our Education and Music Services Team and Arts Active members of Staff to develop, monitor and review this work and young peoples' opportunities at St David's Hall going forward.

5. Have you sourced and included the views and experiences of children and young people? What do you know about children and young people's views and experiences that are relevant to the proposal? [i - additional info](#)

As part of the Council's budget consultation process for 2023/2024, Cardiff citizens, were asked whether they would support the proposal for an Alternative Operating Model for St. David's Hall by securing a long-term lease arrangement with a tenant.

Overall, 58.6% of respondents to the survey supported the proposal to secure a long-term lease arrangement to manage St David's Hall, more than double the proportion of those against the proposal (25.7%). Within every demographic and income group analysed, more respondents supported the proposal than opposed it. The Budget consultations results were

based on robust sample size of 5,932 responses, including the responses of the Youth Survey designed to encourage engagement with young people.

The Council plans on securing a similar or enhanced offer for young people, schools orchestras, youth orchestras and community groups and intent to offer an exciting, optimised and enhanced youth programme with the new tenant.

STAGE 4: BUDGET

It is important to consider the resource and budgetary elements which are directly attributed to children and young people to enable oversight.

- 6. What is the budget for this policy/ strategy/ project/ procedure/ service?
In your answer, include any allocations specifically for children and young people and whether any of the budget will be used to mitigate negative impacts identified above.**

Booking arrangements for youth groups and young people will remain in line with what currently happens, costs will vary in line with inflation, the stakeholders group will champion reasonable booking costs and ticket pricing. Consideration will be given in special cases where community bookings are unaffordable to certain groups.

STAGE 5: IDENTIFIED ACTIONS

- 7. What actions have been identified or changes made to the policy/ strategy/ project/ procedure/ service as a result of this assessment? [i](#) - additional info**

Click or tap here to enter text.

C: Welsh Language Impact Assessment

Please consult with Bilingual Cardiff for any assistance with completing this assessment
Bilingualcardiff@cardiff.gov.uk

Welsh Language Standards 88-97

Standard 88

Will this proposal have a **differential impact [positive/negative]** on:

	Yes	No	N/A
The opportunities for persons to use the Welsh language?		✓	
Treating the Welsh language no less favourably than the English language?	✓		

Please give details/ consequences of the differential impact, and provide supporting evidence, if any.

There will be a continuing and positive impact on Welsh Language provision if AMG become the new tenant of St David's Hall/Neuadd Dewi Sant. The new tenant will be obliged in the Lease to comply with a Welsh Language Policy which will contain the Welsh Language Standards that are currently followed at St Davids Hall/Neuadd Dewi Sant.

A Memorandum of Understanding (MoU) between AMG, the Council and Classical Music Stakeholders will also be entered into, to support the Classical and Community programme, which will help protect important Welsh Culture activities that are currently established in the programme.

Stakeholders include:

- BBC National Orchestra and Chorus of Wales
- BBC Cardiff Singer of the World
- Welsh National Opera
- An Independent Classical Music Advisor
- Royal Welsh College of Music and Drama
- Cardiff Philharmonic Orchestra
- Cardiff Council
- Academy Music Group

Copies of the property lease and the MoU will be submitted with this assessment.

The proposed lease states:

- The Tenant must comply with the Welsh Language Policy for the Property as approved by the Council. The parties shall review the Language Policy on a regular basis (not more than once per calendar year) and discuss and agree any additional steps or actions either the Landlord or the Tenant could reasonably take to further develop the Language Policy.

The MOU states:

- will commit to using the Welsh language in line with legal and statutory requirements to support the classical music programme in Wales.

This is in addition to the community programme, that will deliver many aspects of supporting Welsh Culture and the Welsh Language, supported by Stakeholders and the work of Arts Active staff, that will assist with the community programming and ensure all parties maintain their commitment to Welsh Language standard legislation.

Note – that primary stakeholders are publicly committed to the use of the Welsh Language and are guided by their own Welsh Language policy.

Standard 89

Could this proposal be formulated or re-formulated, so that it would have positive effects, or increased positive effects, on:

The opportunities for persons to use the Welsh language?

We are working to secure a future for St Davids Hall/Neuadd Dewi Sant. Securing the investment needed will help protect the future for the building and its continued use as a concert hall, this proposal is working to ensure the venue stays open, safe and stays operating.

The MoU as referred to above will be implemented by an expert stakeholders group, that will advise and have significant input into the direction of the classical and community programme at the hall. The organisations involved, all have a deep commitment to Welsh Culture and promoting the Welsh Language, as well as committed to complying with Welsh Language standards.

This stakeholder group will help develop a work programme to enhance the classical and community programme in the venue, that will ensure concerts and activity that promotes Welsh Culture, Welsh Music, Welsh celebratory concerts and Welsh schools and Youth music concerts can continue to be enjoyed and developed at the venue.

The tenant will continue to employ staff who are fluent in the Welsh Language, offering the same box office Welsh Language engagement offer that currently exists.

Welsh Language programme notes will continue to be offered as they are now, where relevant for classical and community concerts.

The need for bilingual signage is recognised by the proposed new tenant.

The new tenant is familiar with Welsh Legislation, including the Well Being and Future Generations act and the commitment to the Welsh Language in that legislation.

The new tenant is familiar with the Welsh Language Standards legislation and is happy to continue to follow that in St David's Hall.

The Council has recommended that the new tenant retains the name St David's Hall and Neuadd Dewi Sant as part of any rebranding exercise.

Treating the Welsh language no less favourably than the English language?

The new tenant will be obliged to operate in accordance with Welsh Language Standards, as the Council, currently does.

Standard 90

Could this proposal be formulated or re-formulated to ensure that it does not have adverse effects, or a decreased adverse effect, on:

The opportunities for persons to use the Welsh language?

Please note the points made in Standard 88 and Standard 89, which outlines stakeholders' commitment to the classical and community programme.

Since the beginning of this process, the Council has been emphatic of the importance of the Welsh Language to the classical and community programme of St David's Hall. Therefore, all work and conversations have been based on that any new arrangement would not have an adverse effect on a person's opportunity to use the Welsh Language.

Treating the Welsh language no less favourably than the English language?

Please refer to points made above regarding lease, MoU and Stakeholders programme of work. To clarify, these arrangements mitigate against a decreased effect on opportunities for people wanting to use the Welsh Language at that venue.

Standard 91

When consulting on the proposal, were views considered, and sought, on the effects (both positive and negative) that it would have on:

The opportunities for persons to use the Welsh language?

The Council has emphasised from the start of this process and in all negotiations, that the Council would wish for any new operator to offer the same opportunities for the use of the Welsh Language at the venue, follow Welsh Language Standards and agreeing a policy to support this work.

The Council will require AMG to act like the Council would have to on this specific issue.

The Council remains on the Classical Music Stakeholders group, along with BBC National Orchestra of Wales, BBC Cardiff Singer of the World, Welsh National Opera, Cardiff Philharmonic the Royal Welsh College of Music and Drama and the Academy Music Group.

Reassurance was communicated to the Director of BBC Cymru Wales on the continuation of a St David's Hall bilingual offer by the Council, when the BBC enquired on what approach a new

tenant might take in respect of complying with Welsh Language Standards for the Classical and Community programme.

The conversations also involved ticketing, show notes and programmes produced by the stakeholders. Reassurances have been given by AMG on all accounts.

Treating the Welsh language no less favourably than the English language?

Yes, this was looked at and the current position, is the Welsh Language would be treated no less favourably.

Standard 92

Did the consultation seek and give consideration to views on how the proposal could have positive, or increased positive effects, on:

The opportunities for persons to use the Welsh language?

Yes, as above, to reiterate, the positive effects can be managed through the MoU.

Treating the Welsh language no less favourably than the English language?

Yes, this was looked at and the current position, is the Welsh Language would be treated no less favourably.

Standard 93

Did the consultation seek and give consideration to views on how the proposal could have no adverse effects, or decreased adverse effects, on:

The opportunities for persons to use the Welsh language?

Yes, as noted above, by working to maintain the existing approach at the venue.

Treating the Welsh language no less favourably than the English language?

Yes, as above.

Standard 94

If the proposal includes the awarding of grants, has consideration been given to the guidance presented in Cardiff Council's Policy on Awarding Grants in Compliance with the Welsh Language Standards with regard to:

The opportunities for persons to use the Welsh language?

N/A

Treating the Welsh language no less favourably than the English language?
N/A

Standard 95

If research was undertaken or commissioned to assist with the development of the proposal, did it give consideration to whether it would have a **differential impact [positive/negative]** on:

The opportunities for persons to use the Welsh language?
N/A

Treating the Welsh language no less favourably than the English language?
N/A

Standard 96

Did the research undertaken or commissioned to assist with the development of the proposal give consideration to how it could have a positive effect, or increased positive effects, on:

The opportunities for persons to use the Welsh language?
N/A

Treating the Welsh language no less favourably than the English language?
N/A

Standard 97

Did the research undertaken or commissioned to assist with the development of the proposal give consideration to how it could have no adverse effect, or decreased adverse effects, on:

The opportunities for persons to use the Welsh language?
N/A

Treating the Welsh language no less favourably than the English language?
N/A

Material and Services

In addition to the impact assessment to ensure that the proposal meets the requirements of the Welsh Language Standards, consideration must also be given to the supporting materials and services that may be required.

These include (please click on the hyperlinks to view detailed information about the requirements under the Welsh Language Standards):

- [Correspondence](#) - receiving and replying (emails, letters, online communication).
- [Telephone](#) – receiving and answering calls.
- [Meetings & Public Events](#) – public meetings or events, group meetings, consultation, individual meetings.

- [Public Messages – electronic – video](#)
- [Signs, Notices & Display Material](#)
- [Publicity & Advertising](#)
- [Producing Public Documents](#) - policies, strategies, annual reports, corporate plans, guidelines, notices, codes of practice, consultation papers, licences, certificates, rules, brochures, leaflets, pamphlets or cards, ticket/vouchers.
- [Producing Forms](#)
- [Reception Services](#)
- [Websites, Apps and Online Services](#)
- [Social Media](#)
- [Self Service Machines](#)
- [Education Training Courses](#)
- [Public Address Announcements](#)

Are all supporting materials and services compliant with the requirements of the Welsh language standards?

As noted, the transaction is a property lease deal to a 3rd party private company. The Council will impose a Welsh Language Policy which will require the tenant to comply with Welsh Language Standards.

Cardiff Council’s Welsh Language Skills Strategy

This strategy may be viewed here and additional guidance documents have been produced to support its implementation:

- [Assessing Welsh Language Skills and Identifying Welsh Essential Roles](#)
- [Recruitment, Selection, and Interview Procedures and the Welsh Language](#)

Do you have access to sufficient Welsh speaking staff to support the delivery of the proposal in compliance with the requirements of the Welsh language standards?

It is the intention to TUPE across existing FTE Staff at St David’s Hall to AMG, these will include Welsh speaking staff to support the delivery of the proposal in compliance with the requirements of the Welsh Language Standards.

Next Steps

Where it is considered that a Welsh Language Impact Assessment is required, you must append the completed form to the Cabinet or Officer Decision Report. A copy must also be emailed to Bilingual Cardiff Bilingualcardiff@cardiff.gov.uk

D: Habitats Regulations Assessment

	Yes	No
Will the proposal affect a European site designated for its nature conservation interest*, or steer development towards an area that includes a European site, or indirectly affect a European site?	<input type="checkbox"/>	<input type="checkbox"/>

** Only two European sites designated for nature conservation interest lie within Cardiff's boundaries – the Severn Estuary and Cardiff Beech Woods, but be aware if your project affects an area close to a neighbouring authority.*

If the answer is 'Yes', then a screening exercise may need to be conducted to determine if a Habitats Regulations Assessment is required or not.

Contact the [Biodiversity Team](#) who will guide you through the process.

E: Strategic Environmental Assessment

	Yes	No
Does the strategy, policy or activity set the framework for future development consent?	<input type="checkbox"/>	<input type="checkbox"/>

	Yes	No
Is the strategy, policy or activity likely to have significant environmental effects (positive or negative)?	<input type="checkbox"/>	<input type="checkbox"/>

If you have answered 'Yes' to both of the above questions, then a full Strategic Environmental Assessment Screening is needed.

Contact the [Sustainable Development Unit](#) who will guide you through the process.

F: Data Protection Impact Assessment

	Yes	No
Will the proposal involve processing information that could be used to identify individuals?	<input type="checkbox"/>	<input type="checkbox"/>

If the answer is 'Yes', then a Data Protection Impact Assessment may be required.

Click [here](#) to read the guidance and start the Data Protection Impact Assessment process if needed.

For further information, contact the [Data Protection Service](#).

G: Health Impact Assessment

A Health Impact Assessment helps to develop policies and projects that consider the mental, physical and social health and well-being of a population during planning and development. Considering health inequalities and their impacts on local communities is an essential part of any Health Impact Assessment.

Health Impact Assessments will become a statutory requirement for public bodies in specific circumstances in the future. These circumstances have yet to be published by Welsh Government.

For further information and advice, please contact the Wales HIA Support Unit.

Website: [Home - Wales Health Impact Assessment Support Unit \(phwwhocc.co.uk\)](http://phwwhocc.co.uk)

Email: WHIASU.PublicHealthWales@wales.nhs.uk

This page is intentionally left blank